



SOLUTIONS FOR

Industry & Automation

PRODUCT RANGE





We engineer dreams



Contents

INDUSTRY & AUTOMATION SOLUTIONS	5
BONFIGLIOLI PRODUCT RANGE	6
GEAR UNITS	8
Industrial Gearboxes	8
Heavy Duty Industrial Gearboxes.....	18
Precision Planetary Gearboxes	26
ELECTRIC MOTORS	40
Solutions & Applications.....	40
General Purpose.....	44
DRIVES	50
Cabinet drives.....	50
Decentralized drives	58
DIGITAL ENGINEERING TOOLS	62
SOFTWARE FOR ORDERING AND SELECTION	66
ALWAYS BY OUR CUSTOMER'S SIDE, ALL OVER THE WORLD	67
OUR GLOBAL PRESENCE	68

Engineering Solutions



WWW.BONFIGLIOLI.COM



Industry & Automation Solutions

The Industry & Automation Solutions business unit meets the evolving needs of industrial processes and automation. With a focus on innovation and sustainability, we operate advanced Industry 4.0 facilities to serve over 20 sectors. We serve material handling and logistics, food and beverage, metalworking, mining, recycling and sustainable energy technologies, with an international team that delivers a personalized and exceptional customer experience. Our commitment is to provide tailored solutions that address today's complex challenges while driving progress and creating enduring value for customers.



ONE-STOP SHOP
AUTOMATION
PARTNER



ENSURING HIGH
DYNAMICS AND
PRECISION



GLOBAL
DISTRIBUTION
NETWORK



EXPERTISE FOR
CUSTOMIZED
SOLUTIONS



MEET OUR
CUSTOMERS'
NEEDS



IMPROVE
APPLICATION
PERFORMANCE

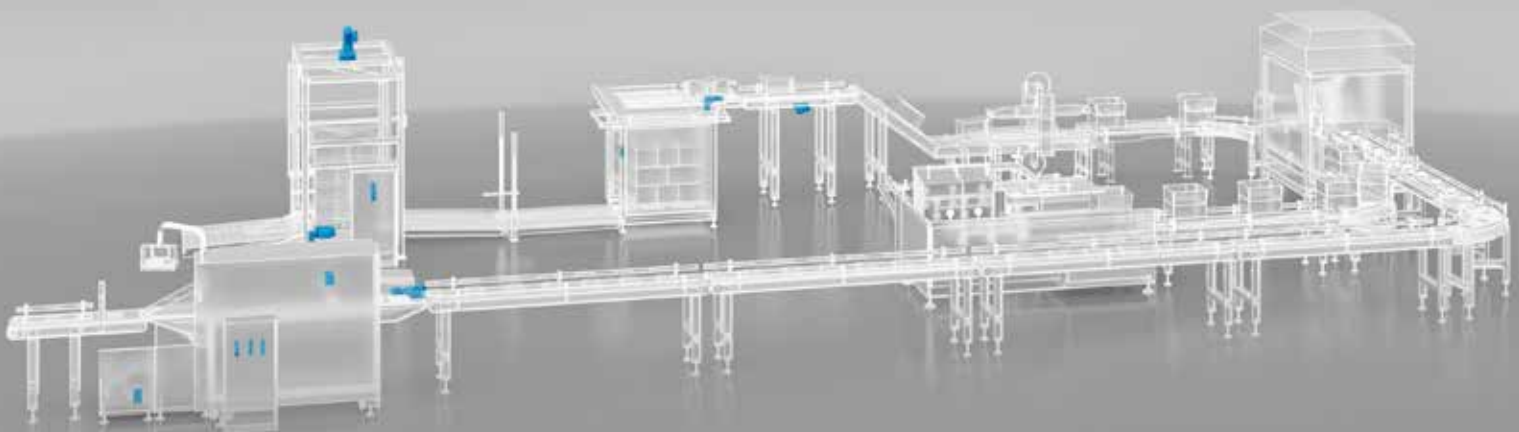

Bonfiglioli product range

Bonfiglioli offers a wide range of products for industrial automation, including gearboxes, motors, inverters, sensors and digital tools. By combining these components, Bonfiglioli provides standard and customized systems and solutions to meet the specific needs of each customer.

Discover more about Bonfiglioli Portfolio!



GEAR UNITS



ELECTRIC MOTORS



DRIVES

**DIGITAL
ENGINEERING
TOOLS**

Gear Units

Bonfiglioli offers a wide range of gearboxes, from worm gearboxes to planetary gearboxes, to meet different torque and speed requirements.

INDUSTRIAL GEARBOXES

We deliver robust and durable power transmission systems across a wide range of industries. Our gearboxes are engineered for extended service life and unwavering performance. Available in a comprehensive range of sizes, reduction ratios and mounting configurations, our products seamlessly integrate into your specific application.

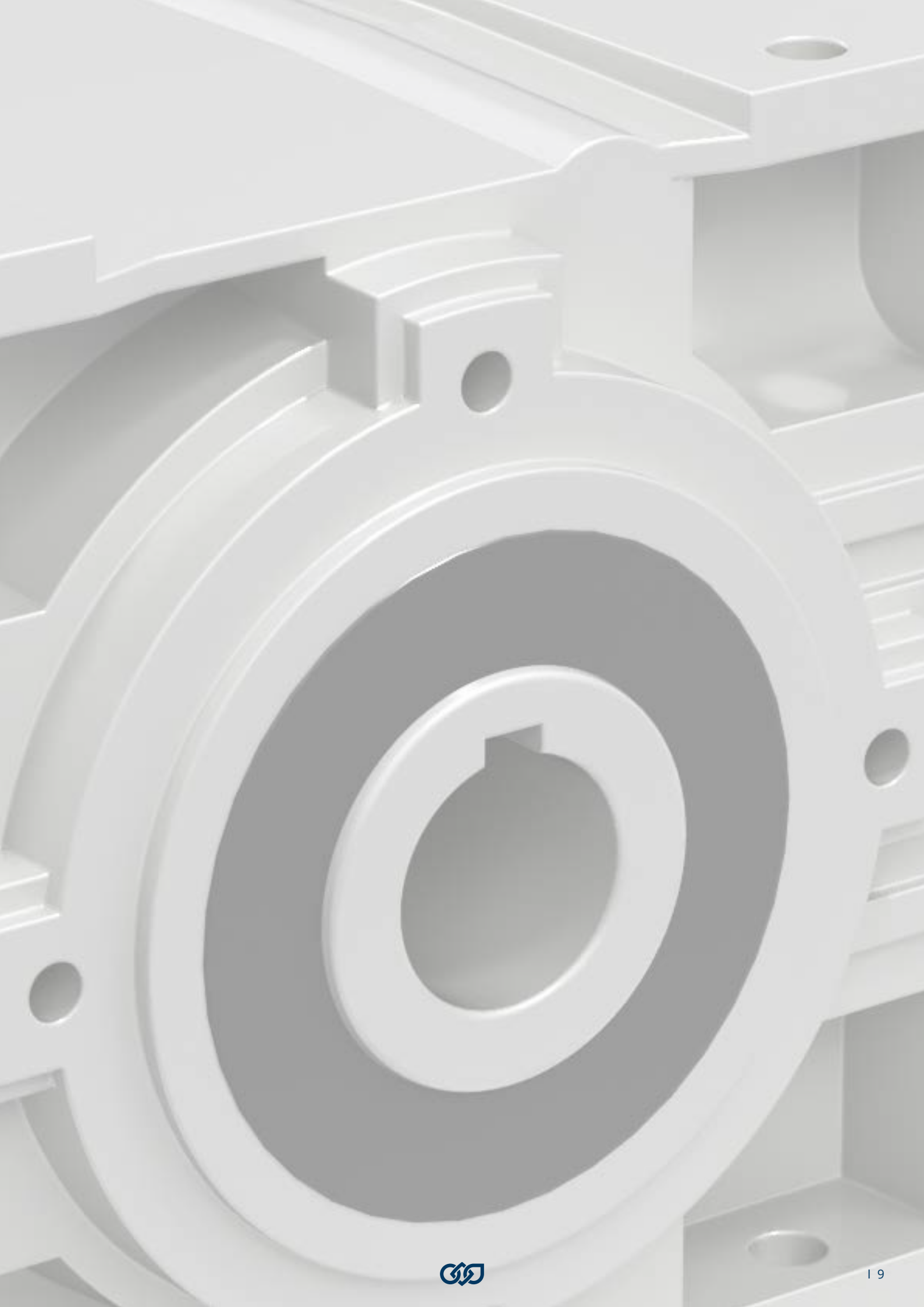

PREMIUM HELICAL IN-LINE

evox

EVOX CP Series

Bonfiglioli EVOX CP offers both easy machine integration, thanks to its standardized footprint, and high-performance, leveraging on high quality helical gear design. With its lifetime lubrication and a unique oil level for all mounting positions, CP guarantees minimal maintenance effort. In addition, the smooth surface design ease cleaning requirements. Available in feet and/or flange variants, the EVOX CP can be adopted in a wide range of application.

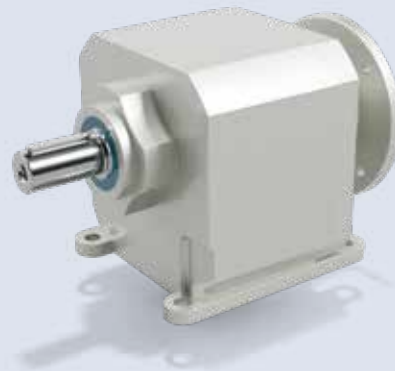

ATEX AVAILABLE

MAIN BENEFITS

- Overall dimension in line with market standards
- Easy-Clean shape
- Compact design for high torque density and maximum power
- Low warehousing cost, thanks to the distinctive universal mounting
- Safe operation in potentially explosive atmospheres

MAIN OPTIONS

Stages		Version			Adapter			
2 STAGES	3 STAGES	FEET AND FLANGE	FEET	FLANGE	IEC	COMPACT	NEMA	SOLID INPUT SHAFT
Oil seal (single/double)		Oil type			Environment			
NBR	FKM	SYNTHETIC	MINERAL	FOOD GRADE	STAINLESS STEEL SHAFT AND PLUG			
Surface protection		Backlash	Bearings	Solid shafts				
PAINTING CLASS UP TO C5		REDUCED BACKLASH	REINFORCED BEARINGS	METRIC	IMPERIAL			

TECHNICAL DATA

Sizes	Nominal torque ⁽¹⁾ [Nm]	Gear ratio range i	Max. adapter size	
CP 07	55	2.8-81.2	IEC	NEMA
CP 17	100	2.4-85.9	56-71	56C
CP 37	200	2.3-133	63-80	56C-145TC
CP 47	335	2.4-172	63-90	56C-184TC
CP 57	500		63-112	56C-184TC
CP 67	600		Coming Soon	Coming Soon

(1) The Nominal Torque is the torque rating representative of the size. The value can change with gear ratio.

UNIVERSAL WORM

VF/W Series

Bonfiglioli's world-renowned VF/W Series since 1956 delivers unwavering quality alongside cost effectiveness. Absolute flexibility comes as standard with a wide variety of mounting options, shaft configurations and motor interfaces.

Furthermore, with several patented manufacturing techniques, the Bonfiglioli VF/W Series stands out for its long operating lifetime and reliability.

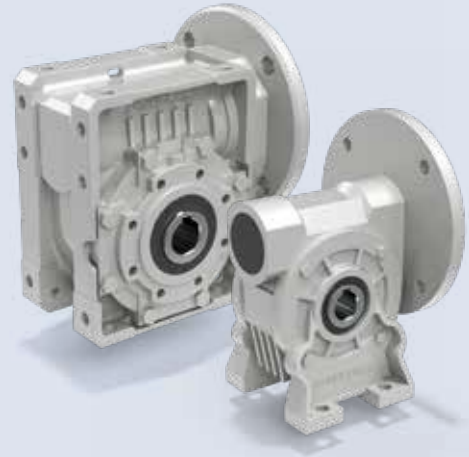

ATEX AVAILABLE

MAIN BENEFITS

- Minimized mounting space
- Designed for enduring performance
- Reduced downtime by effectively absorbing peak loads
- Low noise
- Safe operation in potentially explosive atmospheres

MAIN OPTIONS

Stages			Version		Adapter			
1 STAGE	1 STAGE + PRESTAGE	COMBINED 2*(1 STAGE)	FEET	FLANGE	IEC	COMPACT	NEMA	SOLID INPUT SHAFT
Input shaft	Oil seal		Oil type		Valve	Cover		
EXTENDED SHAFT	NBR	FKM	SYNTHETIC	FOOD GRADE	BREATHER PLUG	SAFETY COVER		
Plug-In Output Shaft	Bearings	Surface protection		Torque limiter	Torque arm			
DOUBLE	IMPERIAL	REINFORCED BEARINGS	PAINTING CLASS UP TO C5		EMBEDDED TORQUE LIMITER	TORQUE ARM		

TECHNICAL DATA

Sizes	Nominal torque ⁽¹⁾	Gear ratio range	Max. adapter size		
	[Nm]		IEC B14	IEC B5	NEMA
VF 27	13	7-70		27	
VF 30	24	7-70	56-63	56-63	42C
VF 44	55	7-6000	56 ⁽²⁾ -71	63-71	42C ⁽²⁾ -56C
VF 49	88	7-6000	63-80	63-80	56C
W 63	190	7-7000	56 ⁽²⁾ -90	56 ⁽²⁾ -90	42C ⁽²⁾ -145C
W 75	320	7-10000	63 ⁽²⁾ -112	63 ⁽²⁾ -112	56C-184TC
W 86	440	7-10000	63 ⁽²⁾ -112	63 ⁽²⁾ -112	56C-184TC
W 110	830	7-10000	63 ⁽²⁾ -112	63 ⁽²⁾ -132	56C ⁽²⁾ -215TC
VF 130	1,500	7-10000	71 ⁽²⁾ -90 ⁽²⁾	71 ⁽²⁾ -132	56C ⁽²⁾ -145TC ⁽²⁾
VF 150	2,000	7-10000	80 ⁽²⁾ -112 ⁽²⁾	71 ⁽²⁾ -160	56C ⁽²⁾ -184TC ⁽²⁾
VF 185	3,600	7-10000	80 ⁽²⁾ -112 ⁽²⁾	71 ⁽²⁾ -180	56C ⁽²⁾ -184TC ⁽²⁾
VF 210	5,000	7-10000		90 ⁽²⁾ -225	
VF 250	7,100	7-10000		90 ⁽²⁾ -225	

(1) The Nominal Torque is the torque rating representative of the size. For the VF-W series, it is calculated in single stage configuration at 500 rpm.

(2) Available only in combined version.

SOLUTIONS FOR Industry & Automation

HELICAL IN-LINE

C Series

The C Series delivers unwavering reliability, efficiency and power. Its robust design and wide torque range handle demanding applications with ease.

Find your perfect match: choose from 2, 3, or 4-stage gearboxes to achieve the precise speed and output you need. Whether for powering conveyor belts or packaging machines, the C Series adapts to your needs.

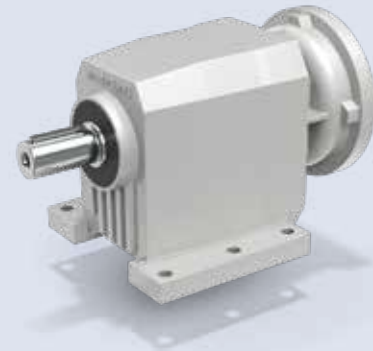

ATEX AVAILABLE

MAIN BENEFITS

- Wide applicability thanks to the extreme range of ratios
- High stiffness for dynamic application
- Wide output speed range
- Safe operation in potentially explosive atmospheres

MAIN OPTIONS

Stages			Version		Adapter				
2 STAGES	3 STAGES	4 STAGES	FEET	FLANGE	IEC	COMPACT	NEMA	SERVO	SOLID INPUT SHAFT
Oil seal (single/double)		Oil type			Valve	Backlash			
NBR	FKM	SYNTHETIC	MINERAL	FOOD GRADE	BREATHER PLUG	REDUCED BACKLASH			
Backstop	Solid shafts		Surface protection						
BACKSTOP	METRIC	IMPERIAL	PAINTING CLASS UP TO C5						

TECHNICAL DATA

Sizes	Nominal torque ⁽¹⁾	Gear ratio range	Max. adapter size	
	[Nm]		i	IEC
C 05	45	5.5-44.7	- ⁽²⁾	- ⁽²⁾
C 12	100	2.8-66.2	63-112	56C-180TC
C 22	200	2.7-261.0	63-112	56C-180TC
C 32	300	2.9-274.7	63-132	56C-210TC
C 36	450	2.7-848.5	63-132	56C-210TC
C 41	600	2.7-855.5	63-132	56C-210TC
C 51	1,000	2.6-884.9	63-180	56C-280TC
C 61	1,600	2.8-796.1	63-180	56C-280TC
C 70	2,300	4.6-1476	63-200	56C-280TC
C 80	4,000	5.6-1481	63-225	56C-320TC
C 90	7,200	5.2-1240	63-250	56C-320TC
C 100	12,000	4.9-1081	63-280	56C-320TC

(1) The Nominal Torque is the torque rating representative of the size. The value can change with gear ratio.

(2) Only available as compact gearmotor



HELICAL BEVEL

A Series

The A series Combines high efficiency and reliability, low maintenance costs and a wide torque range.

The gear set combination makes this the most efficient and durable right-angle solution among the Industrial Gearboxes portfolio.

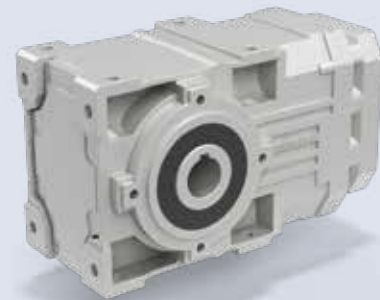

ATEX AVAILABLE

MAIN BENEFITS

- Reduced installation space
- Wide output speed range
- High stiffness for dynamic application
- Safe operation in potentially explosive atmospheres

MAIN OPTIONS

Stages			Version	Torque arm	Adapter				
2 STAGES	3 STAGES	4 STAGES	FLANGE	TORQUE ARM	IEC	COMPACT	NEMA	SERVO	SOLID INPUT SHAFT
Oil seal (single/double)			Oil type		Valve	Surface protection			
TACONITE	NBR	FKM	SYNTHETIC	FOOD GRADE	BREATHER PLUG	PAINTING CLASS UP TO C5			
Cover	Backlash	Backstop	Output Shaft (metric or imperial)			Bearings			
SAFETY COVER	REDUCED BACKLASH	BACKSTOP	HOLLOW SHAFT (keyed or with shrink disk or splined)	SOLID SINGLE	SOLID DOUBLE	REINFORCED BEARINGS			

TECHNICAL DATA

Sizes	Nominal torque ⁽¹⁾	Gear ratio range	Max. adapter size	
	[Nm]		IEC	NEMA
A 05	100	5.5 - 91.6	63-80	56C-140TC
A 10	150	5.5 - 91.6	63-112	56C-180TC
A 20	250	5.4 - 380.9	63-112	56C-180TC
A 30	410	5.4 - 400.8	63-112	56C-180TC
A 35	600	5.4 - 393.2	63-132	56C-210TC
A 41	850	5.2 - 376.8	63-132	56C-210TC
A 50	1,500	7.7 - 778.2	63-180	56C-280TC
A 55	2,000	4.9 - 793.0	63-180	56C-280TC
A 60	2,800	7.9 - 755.4	63-180	56C-280TC
A 70	5,000	9.4 - 1715.0	63-200	56C-280TC
A 80	8,000	9.8 - 1558.0	63-225	56C-320TC
A 90	14,000	9.7 - 1632.0	63-250	56C-320TC

(1) The Nominal Torque is the torque rating representative of the size. The value can change with gear ratio.

SOLUTIONS FOR Industry & Automation

HELICAL PARALLEL

F Series

The F series gearbox is a versatile and compact solution for demanding applications. Its layout, the lateral holes for side mounting and the embedded torque arm minimize the mounting space and simplify installation. Its forced gear-shaft mounting ensures high torsional rigidity and precise operation, even in dynamic applications. The F series also offers a wide ratio range, making it suitable for various needs.



ATEX AVAILABLE

MAIN BENEFITS

- Reduced installation space
- Wide output speed range
- High stiffness for dynamic application
- Safe operation in potentially explosive atmospheres

MAIN OPTIONS

Stages			Version	Adapter				
2 STAGES	3 STAGES	4 STAGES	FLANGE	IEC	COMPACT	NEMA	SERVO	SOLID INPUT SHAFT
Antivibration	Oil seal (single/double)		Oil type			Valve	Backlash	
BUSHING KIT FOR TOUQE ARM	NBR	FKM	SYNTHETIC	MINERAL	FOOD GRADE	BREATHER PLUG	REDUCED BACKLASH	
Backstop	Output Shaft (metric or imperial)		Bearings	Cover	Surface protection			
BACKSTOP	HOLLOW SHAFT (keyed or with shrink disk or splined)	PLUG-IN SOLID SINGLE	REINFORCED BEARINGS	SAFETY COVER	PAINTING CLASS UP TO C5			

TECHNICAL DATA

Sizes	Nominal torque ⁽¹⁾	Gear ratio range	Max. adapter size	
	[Nm]		IEC	NEMA
F 10	140	7.4-127.1	63-112	56C-180TC
F 20	250	6.4-545.3	63-112	56C-180TC
F 25	400	6.9-1374	63-112	56C-180TC
F 31	600	6.9-1539	63-132	56C-210TC
F 41	1,100	6.7-1411	63-132	56C-210TC
F 51	1,800	7.2-1439	63-180	56C-280TC
F 60	2,900	9.0-1141	63-180	56C-280TC
F 70	5,000	10.0-2188	63-200	56C-280TC
F 80	8,000	10.3-1987	63-225	56C-320TC
F 90	14,000	10.3-2099	63-250	56C-320TC

(1) The Nominal Torque is the torque rating representative of the size. The value can change with gear ratio.

HELICAL SINGLE-STAGE

S Series



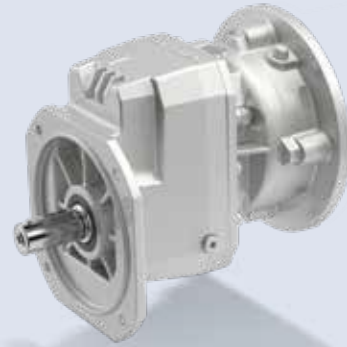











The S Series is suitable for high-speed applications like pumps and fans. Its essential design keeps costs low, while the Unibox housing and forced gear-shaft mounting ensure robustness and precision. Low gear ratios ensure high output speeds, while its dynamic stiffness handles demanding tasks with ease. Choose S Series for power, efficiency and affordability in a compact package.



MAIN BENEFITS

- Specifically designed for long-term high output speed applications (pump, fan)
- Enables cost-effective, high-efficiency power transmission

MAIN OPTIONS

Version		Adapter			Oil type		
							
FEET	FLANGE	IEC	COMPACT	SOLID INPUT SHAFT	SYNTHETIC	MINERAL	FOOD GRADE
Oil seal (single/double)		Valve		Surface protection			
							
NBR	FKM	BREATHER PLUG		PAINTING CLASS UP TO C5			
Solid Shafts		Backstop					
							
METRIC		BACKSTOP					

TECHNICAL DATA

Sizes	Nominal torque ⁽¹⁾	Gear ratio range	Max. adapter size	Max Input Power
	[Nm]	i	IEC	[kW]
S 10	21	1.4-12.3	63-112	1.1
S 20	37	1.4-12.4	63-112	1.8
S 30	70	1.4-13.1	63-132	3.2
S 40	125	1.4-12.4	63-132	6.6
S 50	200	1.4-12.9	63-180	11.6

(1) The Nominal Torque is the torque rating representative of the size. The value can change with gear ratio.

HOIST DRIVE UNITS

HF Series

The new HF Series are the range of drive solutions dedicated for Hoists application in material handling cranes. The design of HF Series has been framed by our synergetic R&D team after performing detailed data analysis of real operating conditions and conducting several interactions with many Crane manufacturers to understand operating challenges faced by them to define needs for special design features which are incorporated in these products.

















The products are designed for higher FEM & ISO classes to have higher safety, high reliability and ensuring higher performances with precise operation of hoists. Additionally, the higher input to output offset and higher space between motor and drum installation provide an advantage to the OEMs to choose from a wide range of drum sizes available in the market.



MAIN BENEFITS

- Rugged structural design with high load carrying capacity
- Higher center & offset distance
- Wide range of output connections provides design flexibility for OEM's
- High performance Gears and Bearings
- Dual Brake options
- Nodular SG Iron Housing for higher load carrying capacity and higher service factors

MAIN OPTIONS

Stages  3 STAGES	Version  FLANGE	Adapter  IEC	Output Shaft  SPLINE SOLID SHAFT WITH WOA FLANGE
Operation class     M5 M6 M7 M8		Oil type  SYNTHETIC	Valve  BREATHER, OIL LEVEL & DRAIN PLUGS
Bearings  REINFORCED BEARINGS	Surface protection  PAINTING CLASS UP TO C5		
Mounting position    H2 (default) H3 H4		Brake options  EXTERNAL BRAKE VERSION (Dual brake)	

TECHNICAL DATA

Sizes	Load	Nominal Torque	Gear ratio	Drum Dia	IEC frame
	Ton	Nm	i	mm	mm
HF 40	up to 5	1100	34.7 – 106.8	140 ... 200	90-112
HF 70	up to 8	2300	28.3 – 139.4	160 ... 240	112-132
HF 125	up to 16	6300	38.5 – 162.7	230 ... 340	132-160

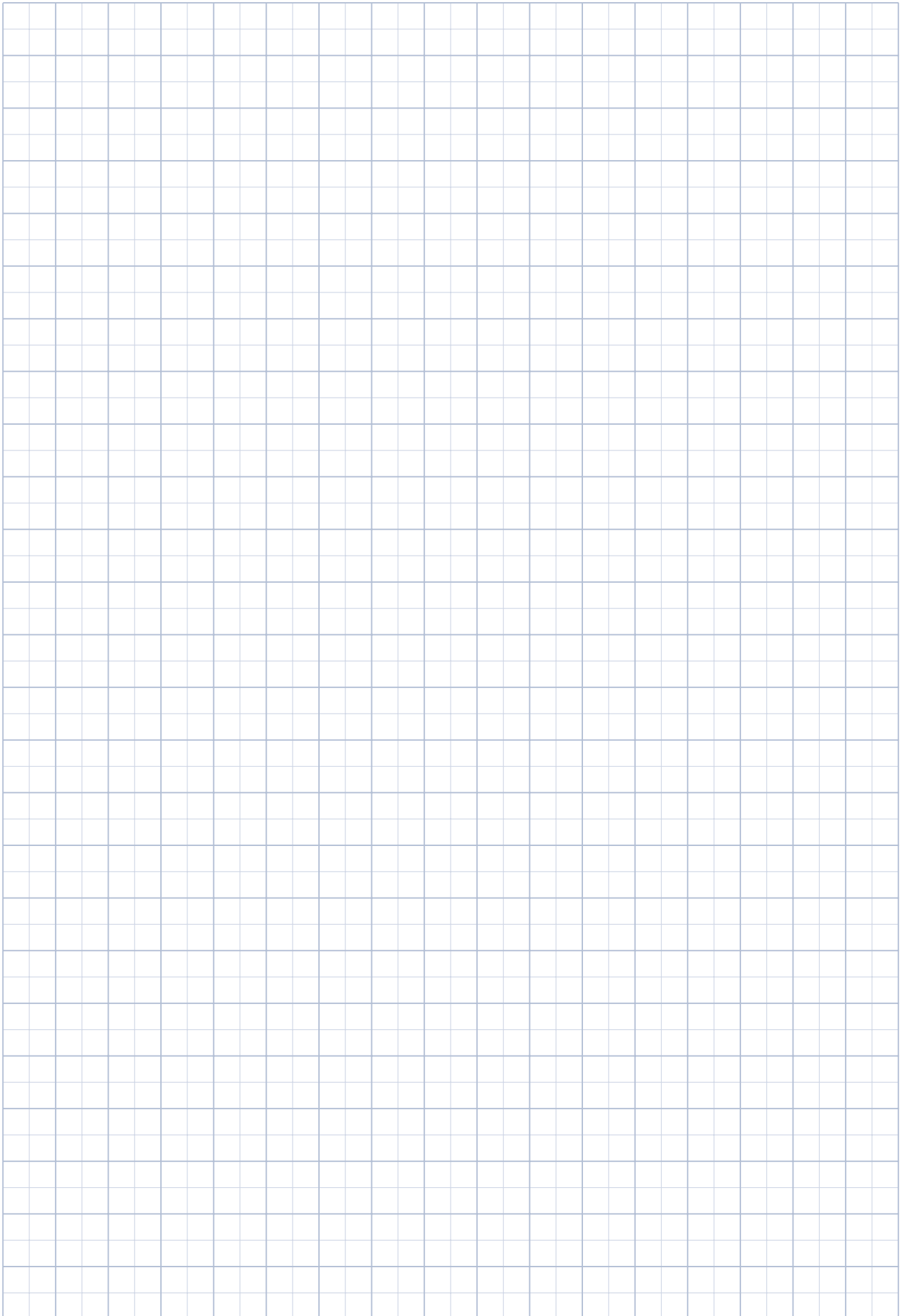

Gear Units

Bonfiglioli offers a wide range of gearboxes, from worm gearboxes to planetary gearboxes, to meet different torque and speed requirements

HEAVY DUTY INDUSTRIAL GEARBOXES

Go beyond the limitations of standard industrial gearboxes with our heavy-duty series.

These gearboxes represent the best in cutting-edge technology and superior materials, ensuring unparalleled performance and unwavering reliability.

Designed to deliver superior durability, increased mechanical torque range and top-tier performance under demanding environmental conditions, our heavy-duty gearboxes are the prime choice for rigorous industrial applications



PLANETARY

300M Series

The 300M Series is an outstanding solution for all heavy-duty applications where compactness and flexibility are a must. Thanks to its modular design, the 300M series can be customized to match an extremely wide range of applications. This planetary gearbox achieves top-class flexibility thanks to the various available output and input configurations and the compatibility with both electric and hydraulic motors. Furthermore, it has a highly transmissible torque/weight ratio and operates without unwanted downtime even in harsh environment or in potentially explosive gas and dust atmospheres



ATEX AVAILABLE

MAIN BENEFITS

- High torque density & peak load capacity
- Max flexibility & high performance to meet any reduction ratio
- Minimized mounting space and weight
- Low maintenance costs

MAIN OPTIONS

Design	Stages	Input versions
IN-LINE RIGHT ANGLE	1 STAGE 2 STAGES 3 STAGES 4 STAGES	INPUT KEYED SHAFT IEC NEMA HYDRAULIC IEC/NEMA WITH INTEGRATED FAN
Cooling	Oil seal (single/double)	Surface protection
INPUT FAN IEC/NEMA with integrated fan AIR/OIL COOLING UNIT	NBR FKM TACONITE	PAINTING CLASS UP TO C5
Torque arm	Output versions	Output fittings
TORQUE ARM	HOLLOW SHAFT SOLID SHAFT FLANGE FEET	FLANGE SHRINK DISK PINION

TECHNICAL DATA

Sizes	Nominal torque ⁽¹⁾ [Nm]	Gear ratio range i	Motor adapter range IEC	Motor adapter range NEMA
300	1,250	3.48-2692	71-132	N56-N280
301	2,460	3.48-2692	71-132	N56-N280
303	2,970	3.60-2799	71-200	N56-N280
304	3,960	3.60-2453	71-200	N56-N280
305	5,800	3.60-2799	71-200	N56-N280
306	10,840	3.60-2916	71-250	N56-N360
307	15,680	3.43-2423	71-250	N56-N360
309	23,240	3.43-2423	71-250	N56-N360
310M	33,460	4.09-2523	71-250	N56-N360
311M	49,210	4.09-2096	71-250	N56-N360
313M	60,940	4.14-2187	71-250	N56-N360
314M	80,640	4.25-1796	132-250	N250-N360
315M	100,800	4.25-1805	132-250	N250-N360
316M	134,390	4.25-1553	132-250	N320-N360
317M	207,490	4.09-1893	132-250	N320-N360
318M	297,550	4.40-1059	180-250	N320-N360
319	471,190	4.08-1389	180-250	N320-N360
321	655,740	4.44-1122	180-250	N320-N360
323	890,310	4.60-1280	200-250	N400
325	1,286,000	4.60-1280	200-250	N400

(1) The Nominal Torque is the torque rating representative of the size. The value can change with gear ratio



COMBINED PLANETARY HEAVY DUTY/HELICAL BEVEL LIGHT DUTY

3/H Series

The 3/H Series combines the high-torque density of planetary gear units with the robustness, optimized cooling efficiency and high-speed operation of the heavy-duty helical bevel products.

This configuration can provide great power transmission in a very compact space. It is designed to meet the needs of high power in a wide range of high output speeds, while complying with all thermal limits.





















The 3/H series also comes with a set of features including cooling circuits, adapted to the customer's needs.



MAIN BENEFITS

- High thermal rating
- Suitable for all heavy-duty applications
- High shock resistance
- Designed to handle the most demanding motor loads
- Wide range of options and equipment

MAIN OPTIONS

Design		Output versions			
	RIGHT ANGLE				
		SHAFT MOUNTED (Hollow splined shaft)	SHAFT MOUNTED (Shrink disk)	SOLID SHAFT (splined / key)	
Input versions		Auxiliary thermal device			
					
INPUT KEYED SHAFT	IEC	NEMA	INPUT FAN	COOLING COIL	
					
			AUTONOMOUS COOLING UNIT	HEATERS	
Forced lubrication		Backstop	Oil seal		Oil sensor
	MECHANICAL OR ELECTRIC PUMP				
		BACKSTOP	TACONITE	NBR	FKM
					THERMOSTAT
Torque arm	Surface protection	Filters			
					
TORQUE ARM	PAINTING CLASS UP TO C5	DESSICANT FILTER BREATHER			

TECHNICAL DATA

Sizes	Nominal torque ⁽¹⁾	Gear ratio range	Motor adapter range	
	[Nm]		IEC	NEMA
3/H 11	46.660	30 - 1099	112 - 280	N180 - N400
3/H 13	58.020	30 - 1113	112 - 280	N180 - N400
3/H 15	96.540	93 - 1160	132 - 315	N210 - N400
3/H 16	128.650	111 - 1160	132 - 315	N250 - N400
3/H 17	196.640	102 - 921	160 - 315	N250 - N440
3/H 18	277.930	99 - 1128	160 - 315	N250 - N440
3/H 19	437.660	105 - 993	160 - 315	N280 - N440
3/H 21	605.930	120 - 960	225 - 315	N320 - N440
3/H 23	822.380	121 - 937	250 - 315	N360 - N440
3/H 25	1.188.610	127 - 1071	250 - 315	N360 - N440

(1) The Nominal Torque is the torque rating representative of the size. The value can change with gear ratio.

SOLUTIONS FOR Industry & Automation

COMBINED PLANETARY HEAVY DUTY/HELICAL BEVEL LIGHT DUTY

3/A Series

The Bonfiglioli 3/A Series combines the high torque density of planetary gear units with the robustness and high speed of helical bevel products. This configuration provides great power transmission in a very compact space, thanks also to its angular layout. The 3/A Series is available for the lower range of the 300M Series and represents a smart path to medium-duty power transmission for the industrial market. With its broad e-motor portfolio, Bonfiglioli can always provide customers an outstandingly balanced solution in terms of efficiency, dynamics and cost-effectiveness.

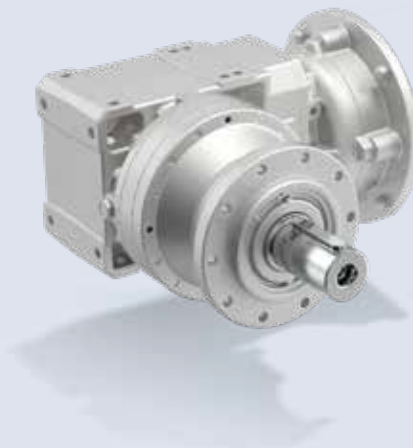

MAIN BENEFITS

- High torque density & peak load capacity
- Modular and adaptable solution
- Low maintenance costs
- Minimized mounting space

MAIN OPTIONS

Design



RIGHT ANGLE



SOLID SHAFT (splined / key)



FEET



SHAFT MOUNTED (Hollow splined shaft)



SHAFT MOUNTED (Shrink disk)

Output fittings



FLANGE



SHRINK DISK



INPUT KEYED SHAFT



IEC



NEMA



COMPACT

Input versions

Oil type



SYNTHETIC

Oil seal



NBR



FKM

Surface protection



PAINTING CLASS UP TO C5

Torque arm



TORQUE ARM

TECHNICAL DATA

Sizes	Nominal torque ⁽¹⁾	Gear ratio range	Motor adapter range	
	[Nm]		IEC	NEMA
3/A 00	1,250	19.1 - 660	63 - 112	N56 - N180
3/A 01	2,460	18.8 - 665	63 - 112	N56 - N180
3/A 03	2,970	19.0 - 731	63 - 112	N56 - N180
3/A 04	3,960	18.7 - 520	63 - 132	N56 - N210
3/A 05	5,800	18.7 - 594	63 - 132	N56 - N210
3/A 06	10,840	27.7 - 671	63 - 180	N56 - N280
3/A 07	15,680	27.1 - 439	63 - 180	N56 - N280

(1) The Nominal Torque is the torque rating representative of the size. The value can change with gear ratio

COMBINED PLANETARY/WORM

3/V Series

The result of over six decades of mastery in worm and planetary gear drive technologies, this series embodies the convergence of unparalleled power and exceptional performance.

The 3/V Series is meticulously engineered for unwavering reliability. Its robust design thrives under relentless stress, including frequent start-stop cycles and harsh environments. This includes potentially explosive gas and dust atmospheres.

The 3/V Series boasts remarkable versatility thanks to its modular design. With a wide range of gear ratios, options and mounting configurations, it adapts to unique needs.



MAIN BENEFITS

- Modular and adaptable solution
- Low maintenance costs
- Minimized mounting space

MAIN OPTIONS

Design



RIGHT ANGLE



SOLID SHAFT
(splined / key)



FEET



SHAFT MOUNTED
(Hollow splined shaft)



SHAFT MOUNTED
(Shrink disk)

Output fittings



FLANGE



SHRINK DISK



INPUT KEYED SHAFT



IEC



NEMA



COMPACT

Input versions

Oil type



SYNTHETIC

Oil seal (single/double)



NBR



FKM

Surface protection



PAINTING CLASS UP TO C5

Torque arm



TORQUE ARM

TECHNICAL DATA

Sizes	Nominal torque ⁽¹⁾	Gear ratio range	Motor adapter range	
	[Nm]		IEC	NEMA
3/V 00	1,250	415 - 2337	63 - 80	N56
3/V 01	2,460	430 - 2337	63 - 80	N56
3/V 03	2,970	395 - 2511	71 - 90	N56 - N140
3/V 04	3,960	384 - 2366	71 - 112	N56 - N180
3/V 05	5,800	396 - 2232	71 - 112	N56 - N180
3/V 06	10,840	395 - 2588	71 - 112	N56 - N180
3/V 07	15,680	386 - 2472	80 - 132	N140 - N210
3/V 09	23,240	370 - 2472	100 - 160	-
3/V 10M	33,640	436 - 4959	100 - 160	N56 - N180
3/V 11M	49,210	430 - 5326	80 - 180	N140 - N210
3/V 13M	60,940	370 - 5046	80 - 180	N140 - N210
3/V 14M	80,640	397 - 4959	100 - 180	-
3/V 15M	100,800	386 - 5234	100 - 225	-
3/V 16M	132,390	397 - 4950	100 - 225	-
3/V 17M	207,490	405 - 4970	100 - 225	-
3/V 18M	297,550	765 - 5099	132 - 225	-
3/V 19	471,190	2582 - 5164	132 - 225	-
3/V 21	655,740	1062 - 5040	132 - 225	-

(1) The Nominal Torque is the torque rating representative of the size. The value can change with gear ratio.

SOLUTIONS FOR Industry & Automation

HELICAL BEVEL HEAVY DUTY

HDO Series

The HDO gearbox series is engineered to handle a wide range of heavy-duty applications. Built with top quality materials and cutting-edge technology, the HDO Series delivers exceptional torque, high reliability and a long life, even in harsh environments or in potentially explosive gas and dust atmospheres. Its high-quality construction ensures maximum torque output, minimizing maintenance and downtime.

With flexible right-angle shaft configurations and a wide range of options and accessories, the HDO Series can be customized to meet the unique requirements of your application.

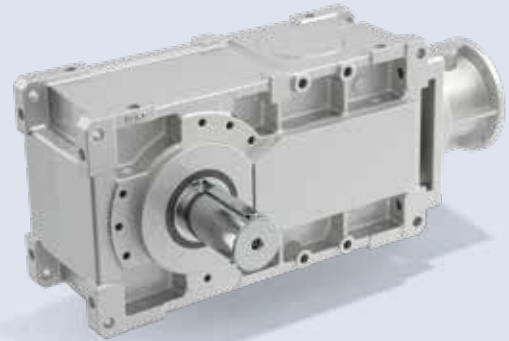

ATEX AVAILABLE

MAIN BENEFITS

- Low maintenance costs
- Minimized mounting space
- Long term stock

MAIN OPTIONS

Stages			Output shafts			Shaft arrangement	
2 STAGES	3 STAGES	4 STAGES	DOUBLE SHAFT	SINGLE SHAFT (right or left)	HOLLOW SHAFT (keyed or with shrink disk)	DOUBLE INPUT SHAFT (lateral and/or upper)	
Input versions			Auxiliary thermal device				
INPUT KEYED SHAFT	IEC	NEMA	INPUT FAN	COOLING COIL	AUTONOMOUS COOLING UNIT	HEATERS	
Forced lubrication		Drywell	Backstop	Bearings	Oil seal		
MECHANICAL OR ELECTRIC PUMP		DRYWELL	BACKSTOP	REINFORCED BEARINGS	TACONITE	NBR	FKM
Filters		Oil sensor	Torque arm	Surface protection			
DESSICANT FILTER BREATHER		THERMOSTAT	TORQUE ARM	PAINTING CLASS UP TO C5			

TECHNICAL DATA

Sizes	Nominal torque ⁽¹⁾	Gear ratio range	Motor adapter range	
	[Nm]	i	IEC	NEMA
HDO 71	8,990	5.6 - 500	132 - 225	N210 - N360
HDO 81	14,740	5.6 - 500	132 - 225	N210 - N360
HDO 91	21,610	7.1 - 500	160 - 280	N250 - N400
HDO 95	23,200	20.0 - 500	160 - 280	N250 - N400
HDO 100	28,210	5.6 - 355	112 - 315	N180 - N400
HDO 110	31,790	6.3 - 400	112 - 315	N180 - N400
HDO 120	41,250	6.3 - 400	132 - 315	N210 - N440
HDO 125	49,240	7.1 - 450	132 - 315	N210 - N440
HDO 130	69,570	5.6 - 355	160 - 315	N250 - N440
HDO 140	87,060	6.3 - 400	160 - 315	N250 - N440
HDO 150	117,200	5.6 - 250	160 - 315	-
HDO 160	147,070	7.1 - 280	160 - 315	-

(1) The Nominal Torque is the torque rating representative of the size. The value can change with gear ratio



HELICAL PARALLEL SHAFT HEAVY DUTY

HDP Series

The HDP gearbox series is engineered to handle a wide range of heavy-duty applications. Built with top quality materials and cutting-edge technology, the HDP Series delivers exceptional torque, high reliability and a long life, even in harsh environments or in potentially explosive gas and dust atmospheres. Its high-quality construction ensures maximum torque output, minimizing maintenance and downtime. With flexible parallel shaft configurations and a wide range of options and accessories, the HDP Series can be customized to meet the unique requirements of your application.

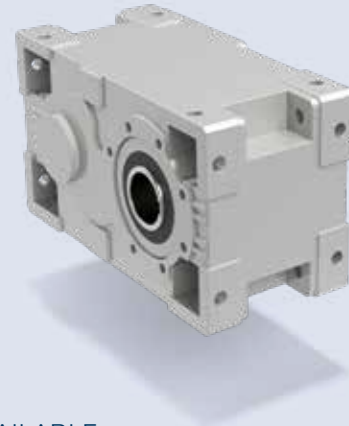

ATEX AVAILABLE

MAIN BENEFITS

- Low maintenance costs
- Minimized mounting space
- Long term stock

MAIN OPTIONS

Stages			Output shafts			Shaft arrangement	
2 STAGES	3 STAGES	4 STAGES	DOUBLE SHAFT	SINGLE SHAFT (right or left)	HOLLOW SHAFT (keyed or with shrink disk)	DOUBLE INPUT SHAFT	
Input versions			Auxiliary thermal device				
INPUT KEYED SHAFT	IEC	NEMA	INPUT FAN	COOLING COIL	AUTONOMOUS COOLING UNIT	HEATERS	
Forced lubrication		Drywell	Backstop	Bearings	Oil seal		
MECHANICAL OR ELECTRIC PUMP		DRYWELL	BACKSTOP	REINFORCED BEARINGS	TACONITE	NBR	FKM
Filters	Oil sensor	Torque arm	Surface protection				
DESSICANT FILTER BREATHER	THERMOSTAT	TORQUE ARM	PAINTING CLASS UP TO C5				

TECHNICAL DATA

Sizes	Nominal torque ⁽¹⁾	Gear ratio range	Motor adapter range	
	[Nm]	i	IEC	NEMA
HDP 60	5,190	7.1 - 100	132 - 225	N210 - N360
HDP 70	7,080	8.0 - 112	132 - 225	N210 - N360
HDP 80	12,600	8.0 - 112	160 - 280	N250 - N400
HDP 90	17,900	8.0 - 112	160 - 280	N250 - N400
HDP 100	28,210	7.1 - 500	112 - 315	N180 - N400
HDP 110	31,790	8.0 - 500	112 - 315	N180 - N400
HDP 120	41,250	8.0 - 500	132 - 315	N210 - N440
HDP 125	49,240	9.0 - 500	132 - 315	N210 - N440
HDP 130	69,570	7.1 - 500	160 - 315	N250 - N440
HDP 140	87,060	8.0 - 500	160 - 315	N250 - N440
HDP 150	117,200	8.0 - 315	160 - 315	-
HDP 160	147,070	9.0 - 355	160 - 315	-

(1) The Nominal Torque is the torque rating representative of the size. The value can change with gear ratio

Gear Units

Bonfiglioli offers a wide range of gearboxes, from worm gearboxes to planetary gearboxes, to meet different torque and speed requirements

PRECISION PLANETARY GEARBOXES

Since decades, Bonfiglioli is a trusted partner for innovative, efficient and highly reliable precision planetary gearboxes (PPGs).

Engineered for excellence, our PPGs offer unmatched quality, extreme compactness and a wide variety of configurations, enabling long lasting operation in dynamic applications.

(P) PERFORMANCE LINE

(E) EFFECTIVE LINE

PRECISION PLANETARY INLINE GEARBOXES

(P)

TQ Series

The TQ series scores across all performance categories, offering high torque density, good overload capacity, high precision and extreme stiffness.

Specifically designed to meet the rigorous demands of servo systems, the TQ range is ideally suited for applications requiring rapid dynamics and precise positioning.



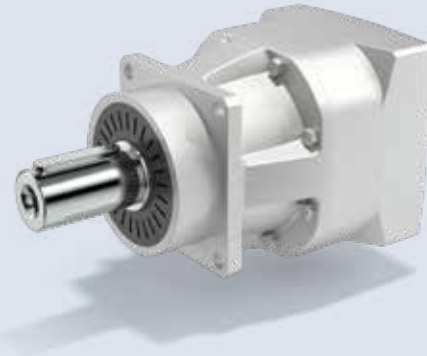







Its robust design ensures reliability and efficiency even in the most challenging operational conditions.



MAIN BENEFITS

- Maximum power density across the Precision Gearbox range
- Ideal for applications with demanding load cycles with strong accuracy requirements and high dynamics
- The reinforced bearings option allows TQ to work in applications with challenging external loads
- Easy retrofit thanks to an output interface widely available in the market
- Suited to various environments thanks to its IP65 protection class

MAIN OPTIONS

Input versions		Lubrication		Output shafts versions	
					
MOTOR ADAPTER	WITHOUT MOTOR ADAPTER	STANDARD	UH1 FOOD GRADE	SMOOTH KEYLESS SHAFT	KEYED SHAFT
Bearings versions			Service type		
					
STANDARD	REINFORCED	S1	S5		

TECHNICAL DATA

Sizes	Nominal torque ⁽¹⁾ [Nm]	Gear ratio range i	Torsional Backlash ⁽¹⁾		Torsional Stiffness [Nm/arcmin]	Max Tilting Moment [Nm]
			Reduced	Standard		
060	30	3-100	2	4	4,8	129,5
070	70	3-100	2	4	11,3	343 ⁽²⁾
090	200	3-100	2	3	28	772 ⁽²⁾
130	400	3-100	2	3	59	1233
160	800	3-100	2	3	170	2331

1) Best available value for each size.

2) Valid for "Reinforced bearings" version.

PRECISION PLANETARY RIGHT ANGLE GEARBOXES

(P)

TQK Series



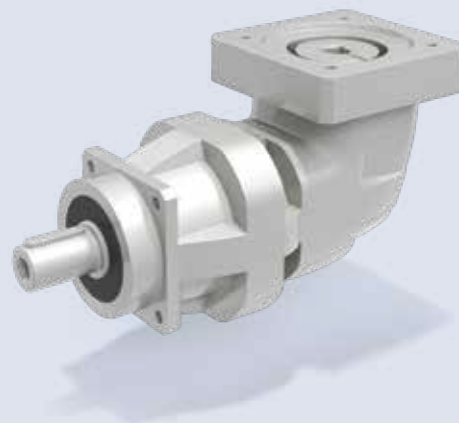







The TQK right-angle series presents an ideal solution for space-saving needs while maintaining the superior performance levels inherited from the TQ inline series. This series is particularly suited for the highly demanding requirements of servo systems, such as fast dynamic response, frequent reverse motion, precise position and high number of starts and stops.



MAIN BENEFITS

- Maximum power density across the Precision Gearbox range
- Ideal for applications with demanding load cycles with strong accuracy requirements and high dynamics
- Reinforced bearings option allows TQ to work in applications with challenging external loads
- Easy retrofit thanks to an output interface widely available in the market
- Compact right-angle design for tight installation space
- Fits various environments thanks to its IP65 protection class

MAIN OPTIONS

Input versions		Lubrication		Output shafts versions	
					
MOTOR ADAPTER	WITHOUT MOTOR ADAPTER	STANDARD	UHI FOOD GRADE	SMOOTH KEYLESS SHAFT	KEYED SHAFT
Bearings versions			Service type		
					
STANDARD	REINFORCED	S1	S5		

TECHNICAL DATA

Sizes	Nominal torque ⁽¹⁾ [Nm]	Gear ratio range i	Torsional Backlash ⁽¹⁾		Torsional Stiffness [Nm/arcmin]	Max Tilting Moment [Nm]
			Reduced	Standard		
060	30	6-200	5	6	4,8	129,5
070	70	6-200	5	6	11,3	343 ⁽²⁾
090	200	6-200	4	5	28	772 ⁽²⁾
130	400	6-200	4	5	59	1233
160	800	6-200	4	5	170	2331

1) Best available value for each size.

2) Valid for "Reinforced bearings" version.

PRECISION PLANETARY INLINE GEARBOXES

(P)

TQF Series



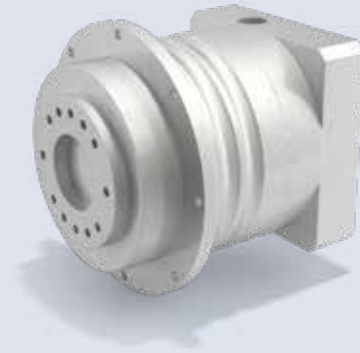



The TQF series represent the best solution for precision applications requiring high overloads and direct mounting to rotating flange shaft. It features a standardized output interface and a very compact design on all of the 5 available sizes. High tilting moment, high stiffness and overload capacity characterize the design of TQF.



MAIN BENEFITS

- TQF extreme torsional stiffness ensures ideal path accuracy even in case of frequent overloads
- Robust installation thanks to the standardized output flange interface
- Dedicated design for continuous (S1) or intermittent (S5) duty cycles
- Fits various environments thanks to its IP65 protection class

MAIN OPTIONS

Input versions		Lubrication		Service type	
					
MOTOR ADAPTER	WITHOUT MOTOR ADAPTER	STANDARD	UHI FOOD GRADE	S1	S5

TECHNICAL DATA

Sizes	Nominal torque ⁽¹⁾ [Nm]	Gear ratio range i	Torsional Backlash ⁽¹⁾		Torsional Stiffness [Nm/arcmin]	Max Tilting Moment [Nm]
			Reduced	Standard		
060	30	4-100	3	5	12	115
070	70	4-100	3	5	29	318
090	200	4-100	3	5	70	430
130	400	4-100	3	5	180	1200
160	800	4-100	3	5	500	3700

1) Best available value for each size.

PRECISION PLANETARY IN-LINE & RIGHT ANGLE GEARBOXES

(P)

TR Series

In addition to optimal performance, very low backlash, high overload capacity and easy installation, the TR series is a well consolidated and reliable series, providing the best price-performance ratio in precision applications.

Featuring unparalleled modularity, the TR series offers multiple design configurations and a wide range of ratios.

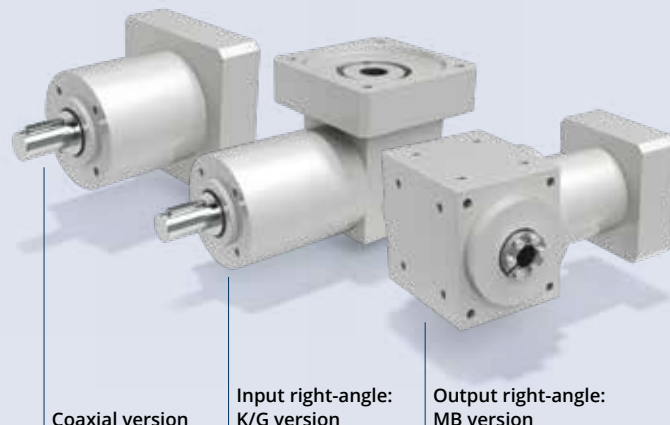

MAIN BENEFITS

- Affordable solution in applications requiring very low backlash and medium dynamics
- Maximum flexibility thanks to a wide range of gear ratios and multiple design configurations
- Great variety of input and output configurations
- Fits various environments thanks to its IP65 protection class

MAIN OPTIONS

Design versions

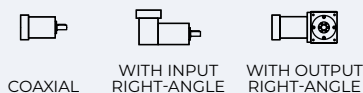

Service type

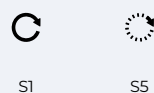

Input versions

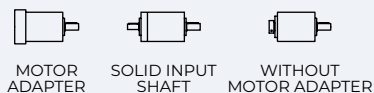

Lubrication



Output shafts versions



Bearings



TECHNICAL DATA

Sizes	Nominal torque ⁽¹⁾ [Nm]	Gear ratio range i	Torsional Backlash ⁽¹⁾		Torsional Stiffness [Nm/arcmin]	Max Tilting Moment [Nm]
			Reduced [arcmin]	Standard		
053	20	3-1000	-	5	1	16
060	30	3-1000	3	5	3	23
080	70	3-1000	3	5	8	155
105	170	3-1000	3	5	24	278
130	450	3-1000	3	5	45	515
160	700	3-1000	3	5	90	739
190	1000	3-1000	3	5	130	1683

1) Best available value for each size.

PRECISION PLANETARY IN-LINE & RIGHT ANGLE GEARBOXES

(E)

MP Series



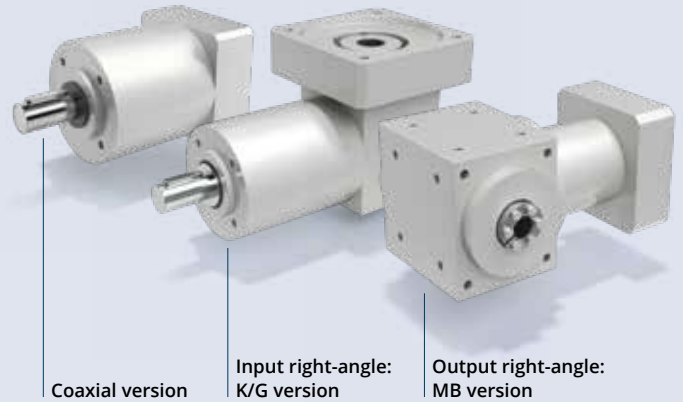











The MP series is distinguished by its extensive torque range across multiple sizes, exceptional modularity through numerous design configurations, a broad range of ratios, and an optimized lubrication system. This guarantees maximum reliability and provides the optimal solution for a broad range of precision applications.



MAIN BENEFITS

- Affordable solution in applications requiring very low backlash and medium dynamics
- Maximum flexibility thanks to a wide range of gear ratios and multiple design configurations
- Great variety of input and output configurations
- Fits various environments thanks to its IP65 protection class

MAIN OPTIONS

Design versions			Service type	
				
COAXIAL	WITH INPUT RIGHT-ANGLE	WITH OUTPUT RIGHT-ANGLE	S1	S5
Input versions			Lubrication	
				
MOTOR ADAPTER	SOLID INPUT SHAFT	WITHOUT MOTOR ADAPTER	STANDARD	FOOD GRADE
Output shafts versions			Bearings versions	
				
SMOOTH KEYLESS SHAFT	KEYED SHAFT	STANDARD	REINFORCED	

TECHNICAL DATA

Sizes	Nominal torque ⁽¹⁾ [Nm]	Gear ratio range i	Torsional Backlash ⁽¹⁾		Torsional Stiffness [Nm/arcmin]	Max Tilting Moment [Nm]
			Reduced [arcmin]	Standard		
053	20	3-1000	10	15	1	16
060	30	3-1000	10	15	3	23
080	70	3-1000	10	15	8	155 ⁽²⁾
105	170	3-1000	10	15	24	278 ⁽²⁾
130	450	3-1000	10	15	45	515
160	700	3-1000	10	15	90	739
190	1000	3-1000	10	15	130	1683

1) Best available value on 1 stage gearbox.

2) Valid for "Reinforced bearings" version.

PRECISION PLANETARY INLINE GEARBOXES

(E)

TQFE Series

The TQFE series delivers a winning combination of high compactness and a standardized flange interface, thus simplifying the mounting process, making it suitable for a wide range of applications. Within our effective line the TQFE series truly shines in its ability to precisely follow the dynamic motion path through its high torsional stiffness. TQFE optimizes the balance between performance, precision, and cost, providing customers with exceptional value for their machines.

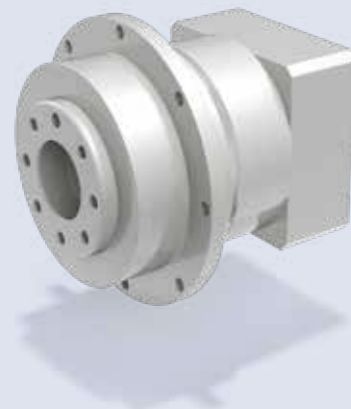

MAIN BENEFITS

- High torsional stiffness ensures stable performance even for demanding load cycles
- High compactness
- Robust installation thanks to the standardized output flange interface, with high market compatibility

MAIN OPTIONS

Input versions

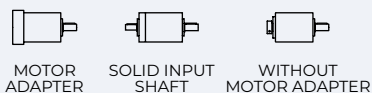

Lubrication



TECHNICAL DATA

Sizes	Nominal torque ⁽¹⁾ [Nm]	Gear ratio range i	Torsional Backlash ⁽¹⁾		Torsional Stiffness [Nm/arcmin]	Max Tilting Moment [Nm]
			Reduced	Standard		
060	30	3-100	5	10	6,5	12
070	65	3-100	5	10	26	50
090	155	3-100	5	10	60	110

1) Best available value for each size.

PRECISION PLANETARY RIGHT ANGLE GEARBOXES

(E)

TQFEK Series

The TQFEK series offers optimized performance and features at an optimum value-price ratio. An exceptionally compact and standardized flange interface combined with optimal positioning accuracy make it suitable for a wide range of industrial applications. Its right-angle design allows more compactness for space-saving layouts.

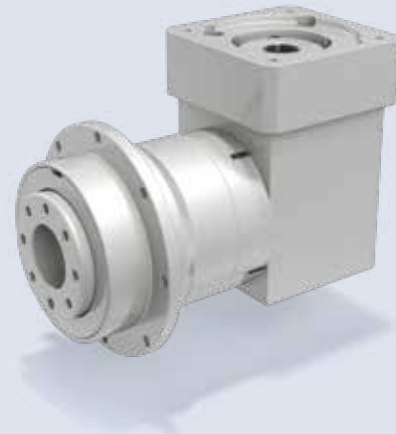

MAIN BENEFITS

- High torsional stiffness ensures stable performance even for demanding load cycles
- Robust installation thanks to the standardized output flange interface, with high market compatibility
- Compact design for space-saving layouts

MAIN OPTIONS

Input versions



MOTOR ADAPTER



WITHOUT MOTOR ADAPTER

Lubrication



STANDARD



UHI FOOD GRADE

TECHNICAL DATA

Sizes	Nominal torque ⁽¹⁾ [Nm]	Gear ratio range i	Torsional Backlash ⁽¹⁾		Torsional Stiffness [Nm/arcmin]	Max Tilting Moment [Nm]
			Reduced [arcmin]	Standard		
060	30	3-100	7	12	6,5	12
070	65	3-100	7	12	26	50
090	155	3-100	7	12	60	110

1) Best available value for each size.

PRECISION PLANETARY INLINE GEARBOXES

(E)

SL Series

The SL series serves as the cornerstone for creating the most compact timing belt drive systems. This series represents the most suitable solution for belt servo-drives, precise conveyors and all other applications requiring accuracy, an ultra-compact design and high radial load capacity. Whenever radial load represents the first limitation in gearbox sizing, SL is the best option.

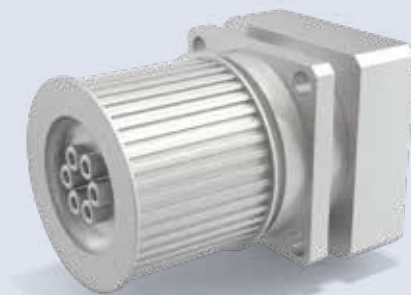

MAIN BENEFITS

- Optimized for timing belt pulley drive systems thanks to the dedicated design and the integrate pulleys (option)
- Extreme compactness
- Great position accuracy

MAIN OPTIONS

Input versions

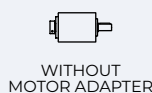

Lubrication



Output shafts versions



High power version (P option)



TECHNICAL DATA

Sizes	Nominal torque ⁽¹⁾ [Nm]	Gear ratio range i	Torsional Backlash ⁽¹⁾		Torsional Stiffness [Nm/arcmin]	Max Tilting Moment [Nm]
			Reduced [arcmin]	Standard		
070	30	3-100	6	12	6,5	54
090	65	3-100	6	12	12	105
120	155	3-100	6	12	45	238

1) Best available value for each size.

PRECISION PLANETARY INLINE GEARBOXES

(E)

LC Series

LC precision planetary gearboxes represent a flexible solution and valuable alternative with optimal performance and reliability levels. The output design in line with market standards ensures great compatibility for easy retrofits and a high level of freedom in project development.

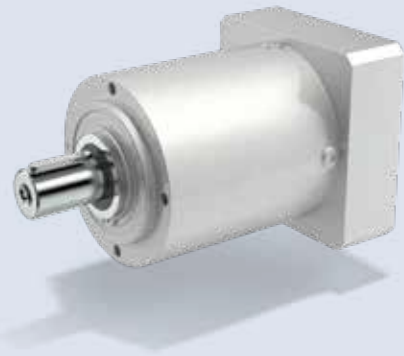

MAIN BENEFITS

- Cost effective yet powerful
- Highly reliable
- High compatibility for easy retrofits

MAIN OPTIONS

Input versions



Lubrication



Output shafts versions



High power version (P option)



HIGH POWER VERSION

TECHNICAL DATA

Sizes	Nominal torque ⁽¹⁾ [Nm]	Gear ratio range i	Torsional Backlash ⁽¹⁾		Torsional Stiffness [Nm/arcmin]	Max Tilting Moment [Nm]
			Reduced [arcmin]	Standard		
050	12	3-100	6	12	0,9	15
070	30	3-100	6	12	3	54
090	65	3-100	6	12	12	105
120	155	3-100	6	12	30	238
155	400	3-100	6	12	50	522

1) Best available value for each size.

PRECISION PLANETARY RIGHT ANGLE GEARBOXES

(E)

LCK Series

LCK precision planetary right-angle gearboxes represent a flexible, reliable and cost-effective solution for machines that require a very compact layout. The output design in line with market standards ensures great compatibility for easy retrofits and a high level of freedom in project development.



MAIN BENEFITS

- Cost effective yet powerful
- High compatibility for easy retrofits
- Quiet running right-angle design, ideal for space saving machine layouts

MAIN OPTIONS

Input versions



MOTOR
ADAPTER



WITHOUT
MOTOR ADAPTER

Lubrication



STANDARD



UHI
FOOD
GRADE

Output shafts versions



SMOOTH
KEYLESS SHAFT



KEYED
SHAFT

High power version (P option)



HIGH POWER
VERSION

TECHNICAL DATA

Sizes	Nominal torque ⁽¹⁾	Gear ratio range	Torsional Backlash ⁽¹⁾	Torsional Stiffness	Max Tilting Moment
	[Nm]		Standard		
050	12	i	[arcmin]	[Nm/arcmin]	[Nm]
070	30	6-100	6	0,9	15
090	60	6-100	6	2,8	54
120	155	6-100	6	11	105
155	450	6-100	6	28,4	238
				47,9	522

1) Best available value for each size.

PRECISION PLANETARY INLINE GEARBOXES

(E)

MPE Series

The MPE series offers a cost-effective solution for applications that require medium levels of positioning accuracy. It offers high flexibility in terms of sizes, ratios and mounting configurations for a variety of application requirements. The output design in line with market standards ensures great compatibility for easy retrofits and a high level of freedom in project development.

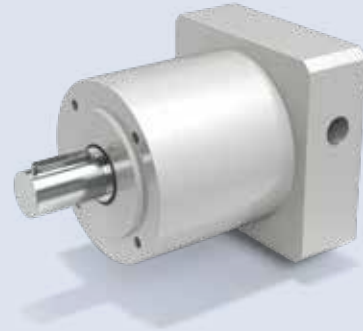

MAIN BENEFITS

- Great price-performance ratio
- High compatibility for easy retrofits
- Suitable for a variety of applications thanks to great design flexibility

MAIN OPTIONS

Input versions

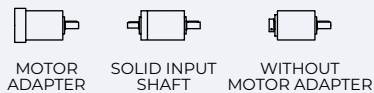

MOTOR ADAPTER SOLID INPUT SHAFT WITHOUT MOTOR ADAPTER

Lubrication



STANDARD FOOD GRADE

Output shafts versions



SMOOTH KEYLESS SHAFT KEYED SHAFT

TECHNICAL DATA

Sizes	Nominal torque ⁽¹⁾ [Nm]	Gear ratio range i	Torsional Backlash ⁽¹⁾		Torsional Stiffness [Nm/arcmin]	Max Tilting Moment [Nm]
			Reduced [arcmin]	Standard		
040	12	3-100	6	12	0,9	15
060	30	3-100	6	12	3	54
080	65	3-100	6	12	12	105
120	155	3-100	6	12	30	238

1) Best available value for each size.

PRECISION PLANETARY RIGHT ANGLE GEARBOXES

(E)

MPEK Series

The MPEK series offers medium levels of performance and position accuracy at a competitive value-price ratio. The output design in line with market standards ensures great compatibility for easy retrofits and a high level of freedom in project development. Its right angle-design allows more compactness for space-saving layouts.

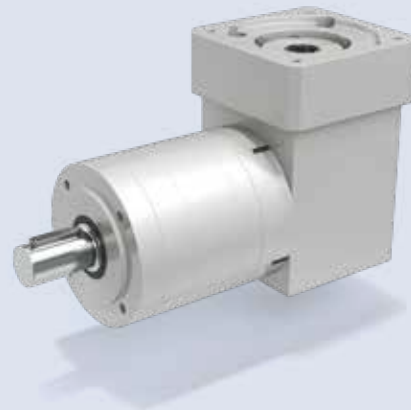

MAIN BENEFITS

- Great price-performance ratio
- High compatibility for easy retrofits
- Suitable for a variety of applications thanks to great design flexibility
- Compact design for space-saving layouts

MAIN OPTIONS

Input versions



MOTOR
ADAPTER



WITHOUT
MOTOR ADAPTER

Lubrication



STANDARD



UHI
FOOD
GRADE

Output shafts versions



SMOOTH
KEYLESS SHAFT



KEYED
SHAFT

TECHNICAL DATA

Sizes	Nominal torque ⁽¹⁾ [Nm]	Gear ratio range i	Torsional Backlash ⁽¹⁾		Torsional Stiffness [Nm/arcmin]	Max Tilting Moment [Nm]
			Reduced [arcmin]	Standard		
060	30	3-100	7	12	2.5	18
080	65	3-100	7	12	11	49
120	155	3-100	7	12	23.4	129

1) Best available value for each size.

PRECISION PLANETARY RIGHT ANGLE GEARBOXES

(E)

KR Series













The KR series provides maximum flexibility for applications requiring a right-angle solution, that fits in tight axial spaces, for medium precision motion. It is available in ratio 1:1, 1:2 and 1:5. The KR series can be adapted to any installation need by choosing among the various available options such as solid/hollow shaft, single/double shaft extension, shrink disk version and with or without output flange.



MAIN BENEFITS

- Best solution for space saving machine layouts requiring low ratios and mid-high precision
- Adaptable to many installation needs, thanks to the wide variety of output configurations
- Dynamic applications can benefit from the reinforced bearings options and the dedicated design for continuous or intermittent duty
- Fits various environments thanks to its IP65 protection class

MAIN OPTIONS

Input versions	Service type	Lubrication
 MOTOR ADAPTER  WITHOUT MOTOR ADAPTER	 S1  S5	 STANDARD  FOOD GRADE
Output shafts versions	Bearings versions	Output flange
 SMOOTH KEYLESS SHAFT  HOLLOW SHAFT (keyed or with shrink disk or splined)	 STANDARD  REINFORCED	 WITHOUT FLANGE (threaded holes)  FLANGE (pass-through holes)

TECHNICAL DATA

Sizes	Nominal torque ⁽¹⁾	Gear ratio range	Torsional Backlash ⁽¹⁾	Torsional Stiffness	Max Radial Load
	[Nm]	i	Standard [arcmin]	[Nm/arcmin]	[N]
010	10	1-2-5	8	0,5	1000
020	24	1-2-5	8	1,4	3000 ⁽²⁾
030	55	1-2-5	8	4	4000 ⁽²⁾
040	120	1-2-5	8	11	5500 ⁽²⁾

1) Best available value for each size

2) Valid for "Reinforced bearings" version

Electric Motors

Bonfiglioli offers asynchronous and synchronous electric motors, in different sizes and powers, to suit any application.

SOLUTIONS & APPLICATIONS

Revolutionize your industrial automation with Bonfiglioli's range of electric motors for solutions and applications. These meticulously crafted motors transcend the limitations of traditional offerings, delivering unparalleled levels of customization, efficiency and performance. Unlock the true potential of your machinery and processes with motors designed to meet your exact requirements.

IE3

evox

BXN/MXN Series

Engineered for peak performance, the BXN/MXN three-phase induction motors deliver exceptional efficiency and reliability. With their modular design and customizable configurations, these motors are the ideal solution for the most demanding industrial application. With a 9-pin connection and global certifications, these motors simplify installation complexities and inventory management. Combined with Bonfiglioli drives, BXN/MXN motors deliver complete, energy-efficient solutions.



INDUCTION TECHNOLOGY

MAIN BENEFITS

- One motor for different markets
- Easy and flexible installation
- Minimized mounting space
- Worldwide voltage coverage with the same efficiency level
- Excellent performance for heavy-duty starts and high loads

TECHNICAL DATA

Sizes	Power [kW]
4 poles	
63MA	0.12
63MB	0.18
71MA	0.25
71MB	0.37
80MA	0.55
80MB	0.75
90S	1.1
90L	1.5
100LA	2.2
100LB	3
112M	4
132S	5.5
132M	7.5

MAIN OPTIONS

Design versions					Global motor	Insulation class	IP protection
B3	B14	B5	B34	B35	CN	UP TO CL H	UP TO IP56
Brake				Anticorrosion	Heaters	Winding treatment	
UNIVERSAL COIL	DC DYNAMIC BRAKE	RELEASE LEVER	MICROSWITCH	UP TO C5*	ANTI CONDENSATION HEATERS	TROPICALIZATION	
Winding protection	Shaft extension	Feedback	Guard		Cable orientation	Rotor balancing	
THERMAL PROTECTIVE DEVICES	SECOND SHAFT	ENCODER	RAIN - TEXTILE GUARD	ENCODER GUARD	CABLE ENTRY POSITION	GRADE B	

* Motors can also be supplied with surface protection class C5 according to UNI EN ISO 12944-2. Contact Bonfiglioli's technical service for further details.

SOLUTIONS FOR Industry & Automation

IE3-IE4

BSR Series

The Bonfiglioli BSR series are 3-phase synchronous reluctance motors suitable for a wide range of industrial applications.

This technology benefits from the proven reliability of an induction motor and the high efficiency and performance of a synchronous one.

For a complete solution, these motors must be operated with Bonfiglioli drives to achieve best in class sensorless speed or position control.

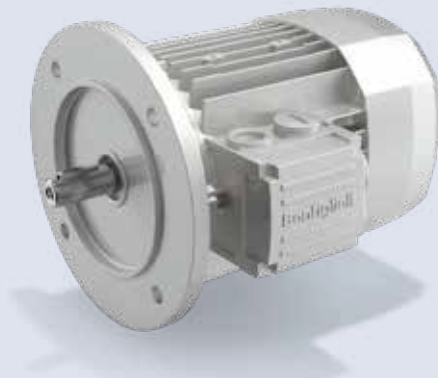

RELUCTANCE TECHNOLOGY

MAIN BENEFITS

- Long life and resistance to harsh operating conditions
- No need for feedback device for positioning
- One or two sizes less compared to asynchronous motors
- Minimal maintenance required
- Sustainable solution
- Excellent performance and dynamics

TECHNICAL DATA

Sizes		Power
High output 3000rpm	High efficiency 1500rpm	[kW]
	71B	0.37
	71C	0.55
	80B	0.75
	80C	1.1
71B	90S	1.5
71C	90L	2.2
80A	100LA	3
80B	100LB	4
80C	112M	5.5
90S	132S	7.5
90L	132MA	9.2
100LB	132MB	11
112M		15
132S		18.5
132MA		

MAIN OPTIONS

Design versions			Insulation class	IP protection	Shaft extension	Guard	Cooling
B3	B14	B5	UP TO CL H	UP TO IP56	SECOND SHAFT	RAIN - TEXTILE GUARD	FORCED VENTILATION
Heaters		Winding treatment	Anticorrosion	Winding protection			
ANTI CONDENSATION HEATERS	TROPICALIZATION	UP TO C5*	THERMAL PROTECTIVE DEVICES				

* Motors can also be supplied with surface protection class C5 according to UNI EN ISO 12944-2. Contact Bonfiglioli's technical service for further details.

SERVO

BMD Series

The Bonfiglioli BMD series are 3-phase synchronous permanent magnet motors with compact dimensions and low/medium inertia suitable for high dynamic industrial applications and agv/amr vehicles. They meet the stringent demands for precision, dynamics and speed settings thanks to their high-quality neodymium iron boron rare-earth magnets and our excellent design. These motors are optimized for operation with drives and precision planetary gearboxes, offering an excellent synergy.

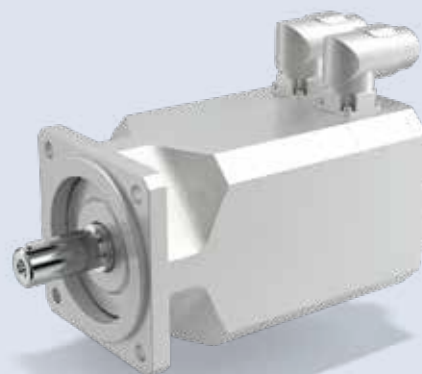

PERMANENT MAGNETS TECHNOLOGY

MAIN BENEFITS

















- Higher power and torque density compared to induction motors
- 14 feedback types, including safety encoders
- Different output interface per motor size and various connectors
- The basic product can operate sensorless with our drives
- Optimized efficiency and energy density leads to low cogging torque
- Modular structure for easy maintenance

TECHNICAL DATA

Sizes	Rated Range [rpm]	Stall Torque [Nm]	
65	1600...6000	0.85	
65	1600...6000	1.7	
65	1600...6000	2.2	
82	1600...6000	3.2	
82	1600...6000	4.4	
102	1600...6000	4.0	
102	1600...6000	7.2	
102	1600...6000	9.6	
118	1600...6000	5.6	
118	1600...6000	10.2	
118	1600...6000	14	
145	1600...6000	16.8	21.5 ⁽¹⁾
145	1600...5500	22	27.5 ⁽¹⁾
170	1600...5500	34	44 ⁽¹⁾
170	1600...4500	45	60 ⁽¹⁾

(1) Motor with forced ventilation option

MAIN OPTIONS

Design versions	Supply	IP protection	Shafts versions	Cooling	Flywheel	Brake
 UP TO 3 INTERFACE B5 PER SIZE	 230V  400V	 UP TO IP67	 KEYLESS SHAFT  KEYED SHAFT	 FORCED VENTILATION	 ADDITIONAL INERTIA	 HOLDING BRAKE
Feedback	Anticorrosion	Winding protection	Connector configuration			
 ENCODER  RESOLVER  SENSORLESS	 UP TO C5*	 THERMAL PROTECTIVE DEVICES	 STRAIGHT	 ROTABLE	 FLYING LEADS	

* Motors can also be supplied with surface protection class C5 according to UNI EN ISO 12944-2. Contact Bonfiglioli's technical service for further details.

Electric Motors

Bonfiglioli offers asynchronous and synchronous electric motors, in different sizes and powers, to suit any application.

GENERAL PURPOSE

Our standard general-purpose motors deliver reliable performance across a wide spectrum of industrial applications. They are built with quality materials and rigorously tested to minimize downtime, ensuring your operations run smoothly and efficiently.



Bonfiglioli



SOLUTIONS FOR Industry & Automation

IE1

BN/M Series ⁽¹⁾

The Bonfiglioli BN/M series of cost-effective 3-phase asynchronous induction motors are perfect for general purpose industrial applications.

These aluminum-framed motors offer: Availability in 2, 4, 6 poles configuration in both IEC and compact version.



INDUCTION TECHNOLOGY

MAIN BENEFITS

- Minimized mounting space thanks to compact flanges
- Minimal maintenance required
- Easy and flexible installation
- Excellent performance for heavy-duty applications
- Many options available
- Several certifications available

TECHNICAL DATA

Sizes			Power [kW]
2 poles	4 poles	6 poles	
	56A		0.06
	56B	63A	0.09
	63A	63B	0.12
63A	63B	71A	0.18
	63C		
63B	71A	71B	0.25
		71C	
71A	71B	80A	0.37
	71C		
71B	80A	80B	0.55
	80B		
71C	80B	80C	0.75
80A	80B	90S	
	80C		
80B	90S	90L	1.1
	90LA		
90SA	90LA	100LA	1.5
90SB	90LB	100LB	1.85
90L	100LA	112M	2.2
100L	100LB	132S	3
112M	112M	132MA	4
132SA	132S	132MB	5.5
132SB	132MA	160M	7.5
132M	132MB		9.2
160MR	160MR		
160M	160M	160L	11
160MB	160L	180L	15
160L	180M	200LA	18.5
180M	180L		22
200LA	200L		30

MAIN OPTIONS

Design versions				Poles	Insulation class	IP protection	Shaft extension	Cooling					
B3	B14	B5	B34	B35	B5R	B14R	2	4	6	UP TO CL H	UP TO IP56	SECOND SHAFT EXTENSION	FORCED VENTILATION
Heaters	Winding treatment	Corrosion protection	Winding protection	Brake			Feedback	Guard	Service type				
ANTI CONDENSATION HEATERS	TROPICALIZATION	PAINTING CLASS UP TO C5 ⁽²⁾	THERMAL PROTECTIVE DEVICES	DC BRAKE	RELEASE LEVER	MICRO SWITCH	ENCODER	RAIN - TEXTILE GUARD	S2	S3			

(1) Starting July 1st, 2021, the Ecodesign Directive (EU) 2019/1781 introduces new binding energy efficiency requirements for induction motors. According to this regulation, BN/M motors are available for discontinuous duty only for powers equal and above 0.12kW.

(2) Motors can be supplied with surface protection class C5 according to UNI EN ISO 12944-2. Contact Bonfiglioli's technical service for further details.



IE2

BE/ME Series ⁽¹⁾

The Bonfiglioli BE/ME series of cost-effective 3-phase asynchronous induction motors are perfect for general purpose industrial applications.

These aluminum-framed motors offer: Availability in 2, 4, 6 poles configuration in both IEC and compact version.



INDUCTION TECHNOLOGY

MAIN BENEFITS

- Minimized mounting space thanks to compact flanges
- Minimal maintenance required
- Easy and flexible installation
- Excellent performance for heavy-duty applications
- Many options available
- Several certifications available

TECHNICAL DATA

Sizes			Power
2 poles	4 poles	6 poles	[kW]
	63A		0.12
	63B		0.18
	71A		0.25
	71B		0.37
	80A		0.55
80A	80B	90S	0.75
80B	90S	100M	1.1
90SA	90LA	100LA	1.5
90L	100LA	112M	2.2
100L	100LB	132S	3
112M	112M	132MA	4
132SA	132S	160MA	5.5
132SB	132MA	160MB	7.5
132MB	132MB		9.2
160MA	160M		11
160MB	160L		15
160L	180M		18.5
	180L		22

MAIN OPTIONS

Design versions				Poles	Insulation class	IP protection	Shaft extension	Cooling
B3	B14	B5	B34	B35	BSR	B14R		
				2	4	6		
					UP TO CL H			
						UP TO IP56		
							SECOND SHAFT EXTENSION	
								FORCED VENTILATION
Heaters	Winding treatment	Corrosion protection	Winding protection	Brake			Feedback	Guard
ANTI CONDENSATION HEATERS	TROPICALIZATION	PAINTING CLASS UP TO C5 ⁽²⁾	THERMAL PROTECTIVE DEVICES	DC BRAKE	RELEASE LEVER	MICRO SWITCH	ENCODER	RAIN - TEXTILE GUARD

(1) Starting July 1st, 2021, the Ecodesign Directive (EU) 2019/1781 introduces new binding energy efficiency requirements for induction motors. According to this regulation, BE/ME motors are available for discontinuous duty only for powers equal and above 0.75kW.

(2) Motors can be supplied with surface protection class C5 according to UNI EN ISO 12944-2. Contact Bonfiglioli's technical service for further details.

SOLUTIONS FOR Industry & Automation

IE3

BX/MX Series ⁽¹⁾

The Bonfiglioli BX/MX series of cost-effective 3-phase asynchronous induction motors are perfect for general purpose industrial applications.

These aluminum-framed motors offer: Availability 4 poles configuration in both IEC and compact version.



INDUCTION TECHNOLOGY

MAIN BENEFITS

- Minimized mounting space thanks to compact flanges
- Minimal maintenance required
- Easy and flexible installation
- Excellent performance for heavy-duty applications
- Many options available
- Several certifications available

TECHNICAL DATA

Sizes	Power [kW]
4 poles	
80B	0.75
90S	1.1
90LA	1.5
100LA	2.2
100LB	3
112M	4
132S	5.5
132MA	7.5
132MB	9.2
160M	11
160L	15
180M	18.5
180L	22
200LAK	30
225SAK	37
225SBK	45
250MAK	55
280SAK	75
280BSK	90
315SAK	110
315SBK	132
315SCK	160
315MAK	200
355MAK	250
355MBK	315
355MCK	355

MAIN OPTIONS

Design versions <p>B3 B14 B5 B34 B35 B5R B14R</p>		Insulation class <p>UP TO CL H</p>	IP protection <p>UP TO IP56</p>	Shaft extension <p>SECOND SHAFT EXTENSION</p>	Cooling <p>FORCED VENTILATION</p>	Heaters <p>ANTI CONDENSATION HEATERS</p>
Winding treatment <p>TROPICALIZATION</p>	Corrosion protection <p>PAINTING CLASS UP TO C5⁽²⁾</p>	Winding protection <p>THERMAL PROTECTIVE DEVICES</p>	Brake <p>DC BRAKE RELEASE LEVER MICRO SWITCH</p>	Feedback <p>ENCODER</p>	Guard <p>RAIN - TEXTILE GUARD</p>	

(1) Starting July 1st, 2023, the Ecodesign Directive (EU) 2019/1781 introduces new binding energy efficiency requirements for induction motors. According to this regulation, BX heavy duty motors without brake are available for discontinuous duty only in the power range from 75 to 200kW.

(2) Motors can be supplied with surface protection class C5 according to UNI EN ISO 12944-2. Contact Bonfiglioli's technical service for further details.



IE4

BY Series

The Bonfiglioli BY series from 75kW to 200kW are 3-phase asynchronous induction motors suitable for general purpose industrial applications. These cast iron-framed motors offer: Availability 4 poles configuration in IEC version.



INDUCTION TECHNOLOGY













MAIN BENEFITS

- High torque at low speeds
- Minimal maintenance required
- Easy and flexible installation
- Excellent performance for heavy-duty applications
- Long life and resistance to harsh operating conditions

TECHNICAL DATA

Sizes	Power [kW]
4 poles	
280SAK	75
280BSK	90
315SAK	110
315SBK	132
315SCK	160
315MAK	200

MAIN OPTIONS

Design versions	Insulation class	IP protection	Shaft extension	Cooling	
 B3  B5  B35	 UP TO CL.H	 UP TO IP56	 SECOND SHAFT	 FORCED VENTILATION	
Heaters	Winding treatment	Corrosion protection	Winding protection	Feedback	Guard
 ANTI CONDENSATION HEATERS	 TROPICALIZATION	 PAINTING CLASS UP TO C5 ⁽¹⁾	 THERMAL PROTECTIVE DEVICES	 HEAVY DUTY ENCODER	 RAIN GUARD

(1) Motors can be supplied with surface protection class C5 according to UNI EN ISO 12944-2. Contact Bonfiglioli's technical service for further details.

Drives

Bonfiglioli offers drives for precise and reliable control of electric motors.

CABINET DRIVES

Elevate your industrial automation with Bonfiglioli's cabinet drives, where power, flexibility and intelligent control converge. Our comprehensive range of inverters seamlessly integrates with your machinery, providing you with the flexibility and performance you need to achieve peak efficiency and productivity.

HIGH PERFORMANCE DRIVES

AxiaVert Series

Bonfiglioli AxiaVert (AXV) series is designed to allow great flexibility and top-level performance, making it suitable for a wide range of applications. Thanks to its modular system, the AxiaVert series offers integrated Functional Safety, optional encoder evaluation and open communication protocols complying with Industry 4.0 standards and an intuitive GUI for commissioning and monitoring. Whether in material working, logistics, automated storage, packaging or textiles, the drives of the AxiaVert series are optimized for numerous applications. The AxiaVert series offers integrated Functional Safety, organized into different variants, which can be selected to best suit the application's requirements, optimizing price and performance to match the machine functions.



MAIN BENEFITS

- Selectable Functional safety features (up to SIL 3 / PL e / CAT. 4)
- Wide power range
- Versatile Communication
- High mounting flexibility
- Wide range of Encoder supports for various systems
- Customizable logic functions with internal optional PLC (IEC61131)
- Integrated PID control system
- Various Control modes incl. Position, Speed or Torque Control & CiA402-compatible Motion Control
- Easy wiring with detachable signal and power terminals (up to 15 kW)
- Macro for EPLAN⁽¹⁾

INCLUDED FIELDBUS



CONTROLLED MOTOR TECHNOLOGY

(Sensorless or with feedback)



Asynchronous induction



Synchronous reluctance



Synchronous permanent magnets

MAIN VARIANTS

Mounting



Fieldbus



Functional Safety

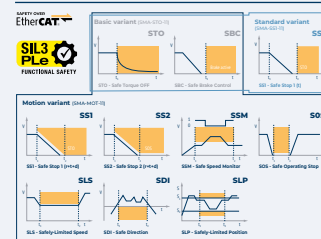

UP TO SIL 3 / PL E / CAT. 4

Feedback evaluation (up to 2, e.g. for speed and position loop)



MAIN OPTIONS

Detachable interfaces



Screen plate



Power accessories



CERTIFICATIONS



TECHNICAL DATA

Voltage		Power
[V]		[kW]
200-240 (1ph) ⁽¹⁾	0.25 - 3.0 in 3 frame sizes	
200-240 (3ph) ⁽¹⁾	0.25 - 9.2 in 4 frame sizes	
400/480 (3ph)		0.25 - 15 in 4 frame sizes

⁽¹⁾ coming soon



DRIVES

ANG Series

Active Next Generation (ANG) is a motion control application inverter that can be used in servo applications and as a drive. The ANG Series offers a wide power range from 0.25 kW to 400 kW (with parallel connection of drives up to 1200 kW). It can control asynchronous and synchronous motors in open and closed loop operations. Field bus communication and encoder evaluation is always on board, making the Active Next Generation Series the perfect drive for motion control applications in closed loop control like packaging, textile machines, food & beverage, warehouse and material handling. For integration in functional safety environments, ANG offers STO functionality according to SIL 3 and PL e.



MAIN BENEFITS

- Functional Safety through STO (Safe Torque Off: SIL3/PLe)
- Wide power range
- Versatile Communication
- High mounting flexibility
- Wide range of Encoder support for various systems
- Customizable logic functions with internal VPLC
- Integrated PID control system
- Different Control modes incl. Position, Speed or Torque Control & CiA402-compatible Motion Control
- Easy wiring with detachable signal and power terminals (up to 4 kW)
- Macro for EPLAN

CONTROLLED MOTOR TECHNOLOGY

(Sensorless or with feedback)



Asynchronous induction



Synchronous permanent magnets

MAIN VARIANTS

Mounting



Fieldbus



Functional Safety



Feedback evaluation



MAIN OPTIONS

Detachable interfaces



Screen plate



Power accessories



CERTIFICATIONS



TECHNICAL DATA

Voltage		Power
[V]		[kW]
200-240 (1ph)	0.25 - 3.0	in 3 frame sizes
200-240 (3ph)	0.25 - 9.2	in 4 frame sizes
400/480 (3ph)	0.25 - 400 (...1200 with parallel connection) in 8 frame sizes	
525 (3ph)	160 - 400 (...1200 with parallel connection)	
690 (3ph)	160 - 400 (...1200 with parallel connection)	

HIGH PERFORMANCE DRIVES

Active Cube Series

Active Cube (ACU) is the high-performance drive with a wide power range from 0.25 kW to 400 kW (with parallel drive connection up to 1200 kW). It can control asynchronous, synchronous and synchronous reluctance motors in open-loop and closed-loop operations. Several optional communication and expansion modules for I/O control and encoder evaluation make the ACU series ideal for a wide range of high-performance applications, such as warehouse and material handling, automatic storage systems, textile machines, packaging, food & beverage, motion control and hoist and crane applications. STO functionality according to SIL 3 and PL e offers easy integration into functional safety environments.



MAIN BENEFITS

- Functional Safety through STO (Safe Torque Off: SIL3/PLe)
- Wide power range
- Versatile Communication
- High mounting flexibility
- Wide range of Encoder support for various systems
- Possibility to customize logic with internal VPLC
- Integrated PID control system
- Different Control modes incl. Position, Speed or Torque Control & CiA402-compatible Motion Control
- Easy cable wiring with detachable signal and power terminals (up to 4 kW)
- Macro for EPLAN

CONTROLLED MOTOR TECHNOLOGY

(Sensorless or with feedback)



Asynchronous induction



Synchronous reluctance



Synchronous permanent magnets

MAIN VARIANTS

Mounting



Functional Safety



MAIN OPTIONS

Fieldbus



Feedback evaluation & IOs



Detachable interfaces



PC-USB INTERFACE



KEYPAD

Screen plate



SCREEN PLATE

Power accessories



BRAKE RESISTORS



LINE CHOKES



EMC FILTERS

CERTIFICATIONS



TECHNICAL DATA

Voltage		Power
[V]		[kW]
200-240 (1ph)	0.25 - 3.0 in 3 frame sizes	
200-240 (3ph)	0.25 - 9.2 in 4 frame sizes	
400/480 (3ph)	0.25 - 400 (...1200 with parallel connection) in 8 frame sizes	
525 (3ph)		160 - 400 (...1200 with parallel connection)
690 (3ph)		160 - 400 (...1200 with parallel connection)

SOLUTIONS FOR Industry & Automation

STANDARD DRIVES

Agile Series

The Agile (AGL) Series is a flexible compromise for standard applications, such as warehouse and material handling (for example: glass, wood, marble), textile machines, food & beverage, packaging, ceramic and hoists applications. The Agile Drive Series has three mechanical sizes for power ranges between 0.12 and 11 kW, with open-loop control for asynchronous and synchronous motors. For integration into functional safety environments, AGL offers STO functionality according to SIL 2 and PL d.



MAIN BENEFITS

- Enhanced safety through STO (Safe Torque Off: SIL2/PLd)
- Compact design for small spaces
- Versatile Communication
- Easy setup & diagnosis with integrated keypad
- High mounting flexibility
- Possibility to customize logic with internal VPLC
- Integrated PID control system
- Macro for EPLAN

INCLUDED FIELDBUS

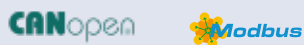

CONTROLLED MOTOR TECHNOLOGY

(Sensorless)



Asynchronous induction



Synchronous permanent magnets

MAIN VARIANTS

Mounting



Functional Safety



MAIN OPTIONS

Fieldbus



Detachable interfaces



PC-USB INTERFACE

Screen plate



SCREEN PLATE

Power accessories



CERTIFICATIONS



TECHNICAL DATA

Voltage		Power
[V]		[kW]
200-240 (1ph)	0.12 - 3.0 in 2 frame sizes	
200-240 (3ph)	0.25 - 7.5 in 3 frame sizes	
400/480 (3ph)		0.25 - 11 in 3 frame sizes



BASIC FREQUENCY INVERTER

S2U Series

Our S2U frequency inverters are designed for simple handling applications and are quickly integrated into your machines. The S2U frequency inverter is available in two mechanical sizes ranging from 0.20 kW to 2.2 kW for 230 V single phase operations. S2U is already preset for corresponding open-loop controlled asynchronous motors. You can also adjust the basic behavior of the drive with a set of 30 parameters. S2U is our solution for compact and economic applications, such as pumps, fans and material handling including packaging and textile machines.



MAIN BENEFITS

- Very compact design for small cabinets
- Easy speed adjustment through integrated potentiometer
- Improved robustness due to fanless design
- Integrated PID control system
- Simple installation with integrated keypad with focus on essential parameters
- Advanced installation with extendable parameter setup
- Macro for EPLAN

INCLUDED FIELDBUS



CONTROLLED MOTOR TECHNOLOGY

(Sensorless)



Asynchronous induction

MAIN VARIANTS

Mounting



STANDARD WALL

MAIN OPTIONS

DIN rail mounting



DIN RAIL

Detachable interfaces



PC-USB INTERFACE

CERTIFICATIONS



TECHNICAL DATA

Voltage	Power
[V]	[kW]
200-240 (1ph)	0.2 - 2.2 in 2 frame sizes

BASIC FREQUENCY INVERTER

S2U IP66 Series

The S2U IP66 frequency inverter series is available in three mechanical sizes, ranging from 0.40 kW to 18.5 kW. S2U is already preset for corresponding open-loop controlled asynchronous motors. S2U IP66 is our compact, robust and economic solution for applications operating in harsh environments, such as pumps, fans and conveyor belts. S2U IP66 frequency inverter, with a simple change of the advanced parameter settings, is also suitable for packaging, textiles, material processing, woodworking and food & beverage applications. The heat sink function is specifically designed for extreme environmental conditions such as dust, humidity and cleaning chemicals.



MAIN BENEFITS

- Robust design for IP66 environments as nearby frequency inverter
- Integrated mains switch for easy installation and switch off
- Easy speed adjustment through the integrated potentiometer
- Improved robustness due to fanless design
- Integrated PID control system
- Advanced installation support with integrated keypad with extendable parameter setup
- Possibility to customize the logic with an internal ladder PLC

INCLUDED FIELDBUS



CONTROLLED MOTOR TECHNOLOGY (Sensorless)



Asynchronous induction

MAIN VARIANTS

Mounting



STANDARD WALL

IP protection



UP TO IP66

MAIN OPTIONS

Detachable interfaces



PC-USB INTERFACE

CERTIFICATIONS



TECHNICAL DATA

Voltage		Power
[V]		[kW]
200-240 (1ph)	0.2 - 2.2 in 2 frame sizes	
400/480 (3ph)		0.75 - 18.5 in 4 frame sizes

ACTIVE REGENERATIVE SYSTEM

AEC Series

Decades of experience in electronic industrial drives and renewable energy have enabled Bonfiglioli to offer an effective solution for recovering braking energy. This solution comes as the new Active Regenerative System inverters (AEC). In a large number of electrically controlled industrial applications, inertia in moving mechanisms can drive electric motors to act as brakes. They convert kinetic energy into electrical energy. In regenerative processes, this energy is returned to the grid.



MAIN BENEFITS

- Energy saving to recover braking or kinetic energy (e.g. hoists)
- Less heat dissipation when feeding to the mains instead of into a brake resistor
- Stabilizes the grid quality through the mains front end feed-in architecture
- Compatibility with Bonfiglioli ACU & ANG drives
- Adjustable Power factor
- Adjustable DC link voltage

FEED-IN CONTROLS



Block feed current control



Sinusoidal feed current control

MAIN VARIANTS

Mounting



MAIN OPTIONS

Fieldbus



IOs



ADD. I/Os

Detachable interfaces



PC-USB INTERFACE

KEYPAD

Screen plate



SCREEN PLATE

Power accessories



SINUS FILTERS



LINE CHOKES



EMC FILTERS

CERTIFICATIONS



TECHNICAL DATA

Voltage	Power
[V]	[kW]
320..440 (3ph)	9,7 - 173,2 kVA in frame sizes 3..7

Drives

Bonfiglioli offers drives for precise and reliable control of electric motors.

DECENTRALIZED DRIVES

Embrace the future of industrial automation with Bonfiglioli onboard inverters, where compact power, unparalleled flexibility and intelligent control converge. These innovative inverters mount directly onto your motors, providing a space-saving, cost-effective solution that allows you to achieve peak performance in even the most challenging environments.

Bonfiglioli



SOLUTIONS FOR Industry & Automation

ONBOARD DRIVES

DGM Series

Bonfiglioli DGM decentralized inverters are suitable for induction asynchronous motors. They have been designed exclusively for industrial or professional use and can be supplied as a complete solution or separately, for wall assembly.

Design and installation are faster compared to inverters installed in electrical cabinets since it is possible to avoid long cables, spend less time on electrical wiring activities and reduce the cabinet dimensions.

Thanks to its robust and vibration-resistant housing concept and various features and options, our high-level performance solution is perfect for pumps and ventilation.



MAIN BENEFITS

- Reduced overall system complexity and wiring
- Enhanced safety through STO (SIL3/PLe)
- Versatile Communication thanks to various fieldbuses
- Possibility to customize the logic directly in the inverter's internal PLC
- Thermal protection included
- Integrated PID control system

MAIN VARIANTS

Fieldbus



Frequency regulation



POTENTIOMETER

IP protection



UP TO IP65

Functional safety



STO

Mounting



ONBOARD



WALL

Digital and Analogue I/O



UP TO 4 DI + 2 DO + 2AI + 1AO

MMI



HANDHELD CONTROLLER

Brake rectifier



RECTIFIER

INCLUDED FIELDBUS



CERTIFICATIONS



CONTROLLED MOTOR TECHNOLOGY



Asynchronous motors

TECHNICAL DATA

Series	Sizes	Power			
		[kW]			
DGM1	A	0.37 - 1.1			
	A	0.55 - 1.5			
DGM3	B		2.2 - 4.0		
	C			5.5 - 7.5	
	D				11 - 22

ONBOARD DRIVES

DGM Modular Series

Bonfiglioli DGM Modular decentralized inverters are suitable for both induction Asynchronous, Permanent magnet synchronous and reluctance synchronous motor control. They have been designed exclusively for industrial or professional use and can be supplied as a complete decentralized solution or separately, for wall assembly. Design and installation are faster compared to cabinet inverters since it is possible to avoid long cables, spend less time on electrical wiring activities and reduce the cabinet dimensions.

Thanks to its robust and vibration-resistant housing concept and various features and options, our high-level performance solution is perfect for Packaging, Logistics, Material handling, Food&Beverage, Material working, and Pumps sectors.



MAIN BENEFITS

- Reduced overall system complexity and cabling
- Enhanced safety through STO (SIL2/PLd)
- Versatile Communication thanks to various fieldbuses
- Sensorless vector control with no need of feedback
- Possibility to customize the logic directly in the inverter's internal PLC
- Possibility to control different motor technologies
- Thermal protection

INCLUDED FIELDBUS

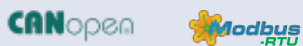

CONTROLLED MOTOR TECHNOLOGY

- Asynchronous motors
- Synchronous reluctance motors
- Permanent magnets motors

MAIN VARIANTS

Fieldbus*				MMI	
ETHERCAT	PROFINET	SERCOS	ETHERNET/IP	HANDHELD CONTROLLER	INTEGRATED MMI
Power grid connectors		IP protection		Frequency regulation	
HARTING	QUICKON	UP TO IP65	POTENTIOMETER	MAIN SWITCH	
Functional safety		Mounting		Digital I/O	
STO	ONBOARD	WALL	UP TO 3 DI + 1 DO	RECTIFIER	

CERTIFICATIONS



TECHNICAL DATA

Sizes	Power			
	[kW]			
A	0.55 - 2.2			
B		2.2 - 5.5		
C			5.5 - 11	
D				11 - 30

* Fieldbus all available as option on top of already included ones.



Digital Engineering Tools

Thanks to a powerful set of software tools and online platforms, developed through partnerships with the main market leaders, Bonfiglioli enables its customers to engineer tailored applications in a smooth and productive way: the components' selection and sizing, as well as the design of the whole motion drive train, are made simpler and more reliable.

Always up-to-date technical data allows for accurate and optimized components' combinations, ensuring the best cost, performance and energy-efficiency trade-off in motion drive train design.

In addition, thanks to its in-depth knowledge on industrial solutions, Bonfiglioli engineering team is in any case available to assist customers in their own selection and design processes, providing high quality technical support for specific applications' developments.



2535
870

MODEL:428

GMB

7239
572



Eplan



ENHANCE YOUR ELECTRICAL DESIGN

Intense competition is putting pressure on machine builders and system integrators to deliver machines with higher throughput and reduced operating cost in shorter timeframes, leading to a significant increase in the complexity of the machine design process.

 DOCUMENTS	 MULTILINGUE SUPPORT	 COMMERCIAL DATA	 LOGIC DATA	 2D/3D DATA	 PRODUCTION DATA
--	--	--	---	---	--

SYSTEM DESIGN CHALLENGE

Bonfiglioli and EPLAN work together to provide efficient engineering solutions, aimed at reducing the gap between the initial concept and its development, programming and commissioning.

- **Better quality of documentation:** the EPLAN Data Portal provides users with up-to-date device data from numerous component manufacturers, saving time for manual data collection and minimizing the risks of faulty data.
- **Shorter system design times:** by including macro-information, function templates, production data and drawings, EPLAN allows users to drag and drop Bonfiglioli drawing templates into their own electrical drawings, reducing the time needed for cabinet planning.

BONFIGLIOLI PRODUCTS AVAILABLE ON EPLAN DATA PORTAL



 ACTIVE NEXT GENERATION SERIES	 ACTIVE CUBE SERIES	 AGILE SERIES	 AXIAVERT SERIES
---	--	---	---

Smart Sizer



COMPLETE SIZING FOR DRIVE AND TRANSMISSION SOLUTIONS

Smart Sizer is a software tool that supports customers in sizing **fully integrated multi-axis servo systems**, including motors, gear units and servo drives, for up to 50 axes in either shared or independent configurations.



INTUITIVE MECHATRONIC SIZING TOOL FOR CUSTOMERS AND CAE ENGINEERS

With Smart Sizer, customers can select, size and design their own customised, high-performance applications. In addition, the Bonfiglioli engineering team, drawing on its in-depth product expertise, uses Smart Sizer to provide a high-quality customer support service, developing optimised, energy-efficient and tailored engineering solutions to meet individual requirements.

BONFIGLIOLI PRODUCTS AVAILABLE ON SMART SIZER

DRIVES SERIES

ASYNCHRONOUS MOTORS SERIES

SYNCHRONOUS MOTORS SERIES

INDUSTRIAL GEAR UNITS SERIES

PRECISION PLANETARY GEAR UNITS SERIES

Software for ordering and selection

Bonfiglioli shop is Bonfiglioli's e-business platform created to facilitate customers purchases and product configuration. Fully integrated with the Bonfiglioli product database, it offers more flexibility to configure a solution and track orders.

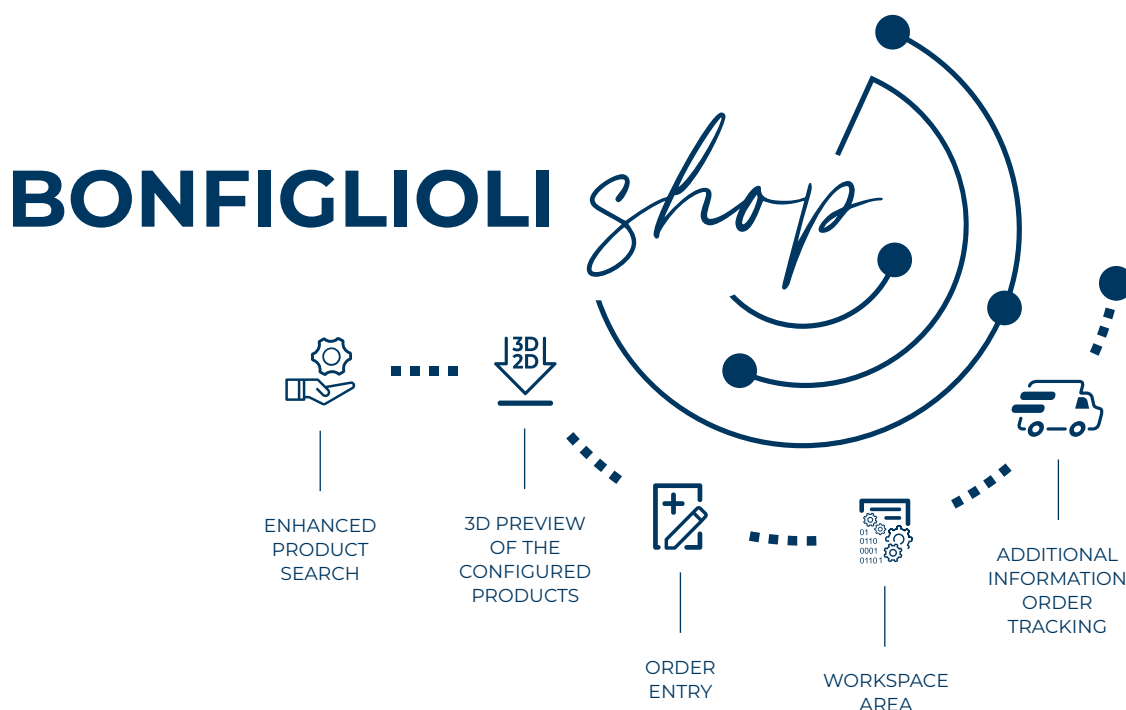

A COMPLETE E-BUSINESS PLATFORM TO BE THE MASTER OF YOUR SOLUTIONS

Bonfiglioli shop guides customers, distributors and agents through the process of selecting the right product for their specific needs and also gives support for design activities and order management. The system greatly accelerates the product selection and ordering process and also guarantees improved security and accuracy.

Thanks to web-based technology, customers can stay connected with Bonfiglioli's technical service 24 hours a day, 365 days a year, from anywhere around the world. Registered customers have access to constantly updated technical specifications and drawings, specifically created for the exact product designation they need. This service provides users with on-line assistance to support them with:

- Configuring Bonfiglioli products
- Downloading technical datas/drawings in 3D and 2D
- Benefiting from Bonfiglioli's help during product selection



Always by our customer's side, all over the world

Our worldwide reach always puts us where our customers need us. We believe that a deep understanding of application requirements — both technical and environmental — make the difference in providing the right products and services in a timely manner.

We provide assistance throughout the product life cycle, from selection to after-sales.



LEAN
MANUFACTURING



INDUSTRY
4.0



FAST DELIVERY
TIMES



WORLDWIDE
PRESENCE

Bonfiglioli has globalized production over the years. Today, we operate 14 manufacturing plants around the world to serve customers in local markets more effectively. Our plants in Italy, Germany, USA, Brazil, India, China, Vietnam and Slovakia form a truly efficient distribution network.

Excellence is our number one priority.

We use the latest technologies to optimize our daily production. Bonfiglioli is fully committed to a more sustainable workplace and supports various local initiatives.

All Bonfiglioli employees pay the utmost attention to even the smallest details, to ensure that our customers receive products and services with unrivalled quality.



Our worldwide presence

Thanks to an international network of closely interconnected commercial and production sites, we can guarantee the same high standards of Bonfiglioli quality anywhere at any given time. We know that our direct presence in local markets is the key to long-lasting success, so our family includes 17 production sites, 23 commercial sites and more than 550 distributors around the world.

Our organization is always close by, offering complete and efficient solutions and supporting our customers with dedicated services, co-engineering and after-sales assistance.

17  PRODUCTION SITES

23  COMMERCIAL SITES

80  COUNTRIES

550  DISTRIBUTORS

~5,000  PEOPLE



Bonfiglioli global locations

AUSTRALIA

Bonfiglioli Transmission (Aust.) Pty Ltd
Plumpton NSW



BRAZIL

Bonfiglioli Redutores do Brasil Ltda
São Bernardo do Campo - São Paulo



CHINA

Bonfiglioli Drives (Shanghai) Co. Ltd.
Shanghai



Selcom Electronics (Shanghai) Co., Ltd
Shanghai



Shanghai



FRANCE

Bonfiglioli Transmission S.A.S.
Marly la Ville



GERMANY

Bonfiglioli Deutschland GmbH
Neuss



Bonfiglioli Deutschland GmbH
Krefeld



O&K Antriebstechnik GmbH
Hattingen



INDIA

Bonfiglioli Transmission Ltd.
Mobility & Wind Industries

Thirumudivakkam
Kancheepuram - Tamil Nadu



Industry & Automation Solutions
Mannur Village, Sriperumbudur Taluk
Kancheepuram - Tamil Nadu



Industry & Automation Solutions
Pune - Maharashtra



ITALY

Bonfiglioli Riduttori S.p.A.
Industry & Automation Solutions
Calderara di Reno (BO)



Industry & Automation Solutions
Carpiano



Mobility & Wind Industries
Forlì



Industry & Automation Solutions
Rovereto



Selcom Group S.p.A.
Castel Maggiore (BO)



Castel Maggiore (BO)



Cadriano (BO)



NEW ZEALAND

Bonfiglioli Transmission (Aust.) Pty Ltd
Auckland - Ellerslie



SINGAPORE

Bonfiglioli South East Asia Pte Ltd
Singapore



SLOVAKIA

Bonfiglioli Slovakia s.r.o.
Považská Bystrica



SOUTH AFRICA

Bonfiglioli South Africa Pty Ltd.
Johannesburg



SPAIN

Tecnotrans Bonfiglioli S.A
Castellbisbal - Barcelona



TURKEY

Bonfiglioli Türkiye Jsc
Çiğli - Izmir



UNITED KINGDOM

Bonfiglioli UK Ltd.
Warrington - Cheshire
Tel. +44 1925 852667



USA

Bonfiglioli USA Inc.
Hebron - Kentucky



VIETNAM

Bonfiglioli Vietnam Co. Ltd.
Ben Cat city, Binh Duong province





We have a relentless commitment to excellence, innovation & sustainability. Our team creates, distributes and services world-class power transmission & drive solutions to keep the world in motion.

HEADQUARTERS

Bonfiglioli S.p.A

Via Cav. Clementino Bonfiglioli, 1
40012 Calderara di Reno - Bologna (Italy)
Tel. +39 051 6473111



REDUCE,
REUSE, RECYCLE.
DOWNLOAD THIS
CATALOGUE:

